

Multi Channel AV Receiver

Operating Instructions

STR-DA2400ES

Owner's Record

The model and serial numbers are located on the rear of the unit. Record the serial number in the space provided below. Refer to them whenever you call upon your Sony dealer regarding this product.

Model No. _____

Serial No. _____

WARNING

To reduce the risk of fire or electric shock, do not expose this apparatus to rain or moisture.

To prevent fire, do not cover the ventilation of the apparatus with newspapers, table-cloths, curtains, etc. And don't place lighted candles on the apparatus.

To prevent fire or shock hazard, do not place objects filled with liquids, such as vases, on the apparatus. Do not install the appliance in a confined space, such as a bookcase or built-in cabinet.

Install this system so that the power cord can be unplugged from the wall socket immediately in the event of trouble.

Batteries or batteries installed apparatus shall not be exposed to excessive heat such as sunshine, fire or the like.

For customers in the United States

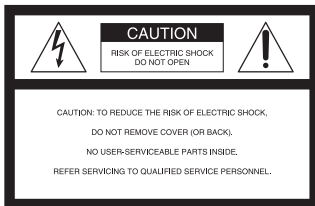

This symbol is intended to alert the user to the presence of uninsulated "dangerous voltage" within the product's enclosure that may be of sufficient magnitude to constitute a risk of electric shock to persons.



This symbol is intended to alert the user to the presence of important operating and maintenance (servicing) instructions in the literature accompanying the appliance.

WARNING

This equipment has been tested and found to comply with the limits for a Class B digital device, pursuant to Part 15 of the FCC Rules. These limits are designed to provide reasonable protection against harmful interference in a residential installation.

This equipment generates, uses, and can radiate radio frequency energy and, if not installed and used in accordance with the instructions, may cause harmful interference to radio communications.

However, there is no guarantee that interference will not occur in a particular installation. If this equipment does cause harmful interference to radio or television reception, which can be determined by turning the equipment off and on, the user is encouraged to try to correct the interference by one or more of the following measures:

- Reorient or relocate the receiving antenna.
- Increase the separation between the equipment and receiver.
- Connect the equipment into an outlet on a circuit different from that to which the receiver is connected.
- Consult the dealer or an experienced radio/TV technician for help.

CAUTION

You are cautioned that any changes or modification not expressly approved in this manual could void your authority to operate this equipment.

Note to CATV system installer:

This reminder is provided to call CATV system installer's attention to Article 820-40 of the NEC that provides guidelines for proper grounding and, in particular, specifies that the cable ground shall be connected to the grounding system of the building, as close to the point of cable entry as practical.

About This Manual

- The instructions in this manual are for model STR-DA2400ES. Check your model number by looking at the lower right corner of the front panel.
- The instructions in this manual describe the controls on the supplied remote. You can also use the controls on the receiver if they have the same or similar names as those on the remote.
- “Neural-THX” and “neural THX” introduced in the Operating Instructions and displayed in the display window and on the GUI menu screen mean Neural-THX Surround.

This receiver incorporates Dolby* Digital and Pro Logic Surround and the DTS** Digital Surround System.

- * Manufactured under license from Dolby Laboratories. Dolby, Pro Logic, Surround Ex, and the double-D symbol are trademarks of Dolby Laboratories.
- ** Manufactured under license under U.S. Patent #'s: 5,451,942; 5,956,674; 5,974,380; 5,978,762; 6,226,616; 6,487,535 & other U.S. and worldwide patents issued & pending. DTS is a registered trademark and the DTS logos, Symbol, DTS-HD and DTS-HD Master Audio are trademarks of DTS, Inc. © 1996-2007 DTS, Inc. All Rights Reserved.

This receiver incorporates High-Definition Multimedia Interface (HDMI™) technology. HDMI, the HDMI logo and High-Definition Multimedia Interface are trademarks or registered trademarks of HDMI Licensing LLC.

XM Ready® is a registered trademark of XM Satellite Radio Inc. All rights reserved.

©2008 SIRIUS Satellite Radio Inc. “SIRIUS” and the SIRIUS dog logo are registered trademarks of SIRIUS Satellite Radio Inc.

This product is manufactured under license from Neural Audio Corporation and THX Ltd. Sony Corporation hereby grants the user a non-exclusive, non-transferable, limited right of use to this product under USA and foreign patent, patent pending and other technology or trademarks owned by Neural Audio Corporation and THX Ltd. “Neural Surround”, “Neural Audio”, “Neural” and “NRL” are trademarks and logos owned by Neural Audio Corporation, THX is a trademark of THX Ltd., which may be registered in some jurisdictions. All rights reserved.

The font type (Shin Go R) installed in this receiver is provided by MORISAWA & COMPANY LTD. These names are the trademarks of MORISAWA & COMPANY LTD., and the copyright of the font also belongs to MORISAWA & COMPANY LTD.

iPod is a trademark of Apple Inc., registered in the U.S. and other countries.

All other trademarks and registered trademarks are of their respective holders. In this manual, ™ and ® marks are not specified.

The Bluetooth word mark and logos are owned by the Bluetooth SIG, Inc. and any use of such marks by Sony Corporation is under license.

Other trademarks and trade names are those of their respective owners.

“M-crew Server” is a trademark of Sony Corporation.

“x.v.Color” and “x.v.Color” logo are trademarks of Sony Corporation.

“BRAVIA” and BRAVIA are trademarks of Sony Corporation.

Table of Contents

Getting Started

Description and location of parts	6
1: Installing the speakers	14
2: Connecting speakers	16
3: Connecting the TV	18
4a: Connecting the audio components	19
4b: Connecting the video components	24
5: Connecting the antennas (aerials)	35
6: Preparing the receiver and the remote	36
7: Operating the receiver using the GUI (Graphical User Interface)	39
8: Setting the speakers	42
9: Calibrating the appropriate speaker settings automatically (Auto Calibration)	44

Playback

Selecting a component	50
Listening to a Super Audio CD/CD	52
Watching a DVD/Blu-ray Disc	53
Enjoying video games	54
Watching video	55

Amplifier Operations

Settings for the audio (Audio settings menu)	56
Settings for the video (Video settings menu)	57
Settings for HDMI (HDMI settings menu)	57
Settings for the system (System settings menu)	58

Enjoying Surround Sound

Enjoying a pre-programmed sound field ...	59
Resetting sound fields to the initial settings	65
Enjoying the surround effect at low volume levels (NIGHT MODE)	66

Advanced Speakers Setting Up

Adjusting the speaker settings manually	66
Adjusting the equalizer	72

Tuner Operations

Listening to FM/AM radio	73
Listening to satellite radio	76

Control for HDMI

Using the Control for HDMI function for “BRAVIA” Sync	87
Preparing Control for HDMI function	89
Watching a DVD (One-Touch Play)	90
Enjoying the TV sound from the speakers connected to the receiver (System Audio Control)	91
Turning off the receiver with the TV (System Power Off)	91

Other Operations

Converting analog video input signals	92
Enjoying the DIGITAL MEDIA PORT adapter (DMPort)	92
Naming inputs	96
Switching between digital and analog audio (INPUT MODE)	97
Enjoying the sound/images from other inputs	98
Changing the display	100
Using the sleep timer	104
Recording using the receiver	104
Using a bi-amplifier connection	105
Operating without connecting to the TV ..	106

Using the Remote

Operating each component using the remote	118
Programming the remote	120
Clearing all the contents of the remote's memory	124

Additional Information

Glossary	125
Precautions	128
Troubleshooting	129
Specifications	135
Index	137

Description and location of parts

Front panel

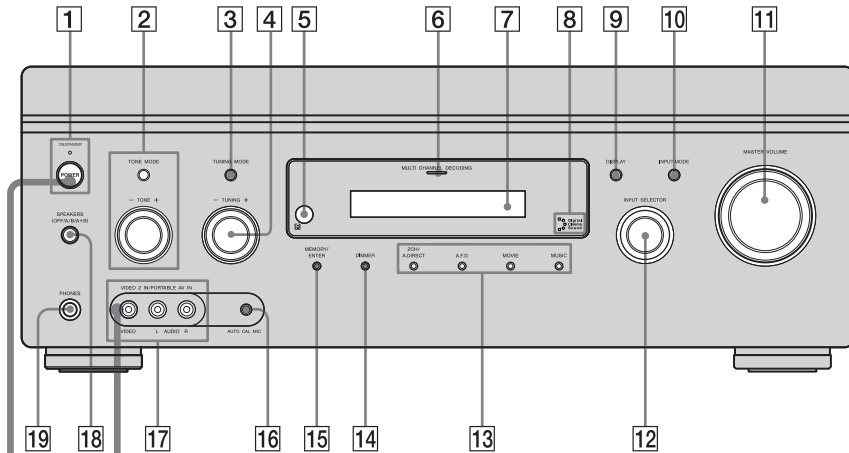

To remove the cover

Press PUSH.

When you remove the cover, keep it out of reach from children.

Status of the POWER button

■ (Off)

The receiver is turned off (initial setting).

The ON/STANDBY lamp lights off.

Press POWER to turn the receiver on. You cannot turn the receiver on using the remote.

■ (On/Standby)

Press I/⏻ on the remote to turn the receiver on or set it to the standby mode.

When you press POWER on the receiver, the receiver will be turned off.

Name	Function
1 POWER	Press to turn the receiver on or off.
ON/STANDBY lamp	Lights up in green when the receiver is turned on. Lights up in red when the receiver is set to standby mode.
2 TONE MODE	Adjusts the tonal quality (bass/treble level) of the front, center and surround speakers. Press TONE MODE repeatedly to select bass or treble level, then turn TONE +/- to adjust the level (page 108).
TONE +/-	
3 TUNING MODE	Press to select the tuning mode (page 115-117).
4 TUNING +/-	Turn to scan a station (page 115-117).
5 Remote sensor	Receives signals from remote commander.
6 MULTI CHANNEL DECODING lamp	Lights up when multi channel audio signals are decoded.
7 Display window	The current status of the selected component or a list of selectable items appears here (page 101).
8 Digital Cinema Sound lamp	Lights up when a sound field with DCS is selected (page 64).
9 DISPLAY	Press repeatedly to select information displayed on the display.

Name	Function
10 INPUT MODE	Press to select the input mode when the same components are connected to both digital and analog jacks.
11 MASTER VOLUME	Turn to adjust the volume level of all speakers at the same time.
12 INPUT SELECTOR	Turn to select the input source to play back.
13 2CH/A.DIRECT A.F.D. MOVIE MUSIC	Press to select sound field (page 114, 115).
14 DIMMER	Press repeatedly to adjust brightness of the display.
15 MEMORY/ ENTER	Press to store a station or enter the selection when selecting the settings.
16 AUTO CAL MIC jack	Connects to the supplied optimizer microphone for the Digital Cinema Auto Calibration function (page 45).
17 VIDEO 2 IN/ PORTABLE AV IN jacks	Connect to a portable audio/video component such as a camcorder or video game.
18 SPEAKERS (OFF/A/B/A+B)	Press to select the speaker system (page 44).
19 PHONES jack	Connects to headphones.

Rear panel

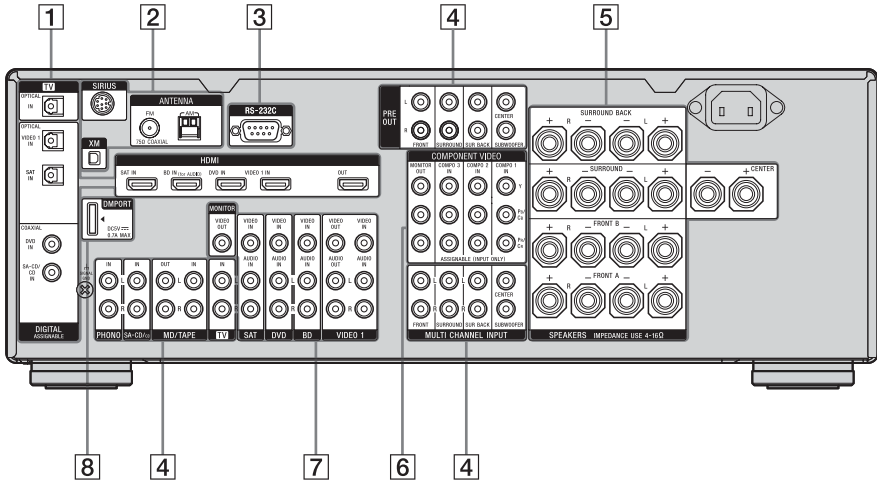

1 DIGITAL INPUT/OUTPUT section



OPTICAL IN/OUT jacks Connect to a DVD player, etc. The **COAXIAL** jack provides a better sound quality (page 18, 20, 29, 30).



COAXIAL IN jacks



HDMI IN/OUT* jacks Connect to a DVD player, Blu-ray Disc Player, or a satellite tuner. The image is output to a TV or a projector while the sound can be output from a TV or/and speakers connected to this receiver (page 18, 26).

2 ANTENNA section



FM ANTENNA Connects to the FM wire antenna (aerial) supplied with this receiver (page 35).



AM ANTENNA Connects to the AM loop antenna (aerial) supplied with this receiver (page 35).



XM jack Connects to the XM Mini Tuner and Home Dock (not supplied) (page 78).



SIRIUS jack Connects to a SiriusConnect Home tuner (not supplied) (page 78).



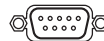











3 RS-232C port













Used for maintenance and service.

Name	Function
1 AV I/⏻ (on/standby)	<p>Press to turn on or off the audio/video components that the remote is programmed to operate.</p> <p>To turn the TV on or off, press TV (24) and then press AV I/⏻.</p> <p>If you press I/⏻ (2) at the same time, it will turn off the receiver and other components (SYSTEM STANDBY).</p> <p>Note</p> <p>The function of the AV I/⏻ switch changes automatically each time you press the input buttons (4).</p>
2 I/⏻ (on/standby)	<p>Press to turn the receiver on or set it to standby mode.</p> <p>To turn off all components, press I/⏻ and AV I/⏻ (1) at the same time (SYSTEM STANDBY).</p> <p>Saving the power in standby mode.</p> <p>When “Control for HDMI” (page 89) and “RS-232C Control” (page 58) is set to “OFF”.</p>
3 AMP	Press to enable the receiver operation (page 106).
4 Input buttons	Press one of the buttons to select the component you want to use. When you press any of the input buttons, the receiver turns on. The buttons are factory assigned to control Sony components (page 50). You can program the remote to control non-Sony components following the steps in “Programming the remote” on page 120.

Name	Function
Numeric buttons (number 5^a)	<p>Press SHIFT (23) and then press numeric buttons to</p> <ul style="list-style-type: none"> – preset/tune to preset stations. – select track numbers of the CD player, VCD player, LD player, DVD player, MD deck, DAT deck, or tape deck. Press 0/10 to select track number 10. – select channel numbers of the VCR, satellite tuner, Blu-ray disc player, PSX, DVD/VHS COMBO, or DVD/HDD COMBO. <p>Press TV (24), and then press the numeric buttons to select the TV channels.</p>
ENT/MEM	<p>Press SHIFT (23) and then press ENT/MEM to</p> <ul style="list-style-type: none"> – enter the value after selecting a channel, disc or track using the numeric buttons of the VCR, CD player, VCD player, LD player, MD deck, DAT deck, tape deck, satellite tuner, Blu-ray disc player, or PSX. – store a station during tuner operation. <p>To enter the value of Sony TV, press TV (24) and then press ENT/MEM.</p>
CLEAR	<p>Press SHIFT (23) and then press CLEAR to</p> <ul style="list-style-type: none"> – clear a mistake when you press the incorrect numeric button of the DVD player, Blu-ray disc player, PSX, satellite tuner, DVD/VHS COMBO, or DVD/HDD COMBO. – return to continuous playback, etc. of the satellite tuner or DVD player.
-/--	<p>Press SHIFT (23) and then press -/-- to select the channel entry mode, either one or two digit of the VCR or satellite tuner.</p> <p>To select the channel entry mode of the TV, press TV (24) and then press -/--.</p>

Name	Function
>10	Press SHIFT (23) and then press >10 to <ul style="list-style-type: none"> – select track numbers over 10 of the CD player, VCD player, LD player, MD deck, tape deck, TV, VCR, or satellite tuner. – select channel numbers of the Digital CATV terminal.
5 2CH/ A.DIRECT	Press to select a sound field (page 114, 115).
A.F.D.	
MOVIE	
MUSIC	
6 SLEEP	Press to activate the Sleep Timer function and the duration which the receiver turns off automatically.
7 NIGHT MODE	Press to activate the Night Mode function (page 66).
8 GUI MODE	Press to display the GUI menu on the TV screen.
9  ,  ,  ,  , 	After pressing AMP (3), press HOME/MENU (11) for receiver operation, then press  /  /  /  to select the settings. After pressing BD/DVD TOP MENU (15) or BD/DVD MENU (15), press  /  /  /  to select the settings, and then press  to enter the selection. Press  also to enter the selection of the receiver, VCR, satellite tuner, DVD player, Blu-ray disc player, PSX, DVD/VHS COMBO, or DVD/HDD COMBO.
10 OPTIONS TOOLS	Press to display and select items from the option menus for receiver, DVD player, Blu-ray Disc Player, Satellite tuner and PSX. Press TV (24) and then press TOOLS to display the options of Sony TV.

Name	Function
11 HOME/ MENU	Press to display the menus of the receiver, VCR, DVD player, satellite tuner, Blu-ray disc player, PSX, DVD/VHS COMBO, or DVD/HDD COMBO on the TV screen. Then, use  /  /  /  and  to perform menu operations. To display the menus of Sony TV, press TV (24) and then press HOME/MENU.
12   b)	Press to skip tracks of the VCR, CD player, VCD player, LD player, DVD player, MD deck, DAT deck, tape deck, Blu-ray disc player, PSX, DVD/VHS COMBO, or DVD/HDD COMBO.
  b)	Press to <ul style="list-style-type: none"> – search tracks in the forward/backward direction of the CD player, VCD player, DVD player, LD player, MD deck, Blu-ray disc player, PSX, DVD/VHS COMBO, or DVD/HDD COMBO. – fast forward/rewind of the VCR, DAT deck, or tape deck.
 a)b)	Press to start playback of the VCR, CD player, VCD player, LD player, DVD player, MD deck, DAT deck, tape deck, Blu-ray disc player, PSX, DVD/VHS COMBO, or DVD/HDD COMBO.
b)	Press to pause playback or recording of the VCR, CD player, VCD player, LD player, DVD player, MD deck, DAT deck, tape deck, Blu-ray disc player, PSX, DVD/VHS COMBO, or DVD/HDD COMBO. (Also starts recording with components in recording standby.)
■ b)	Press to stop playback of the VCR, CD player, VCD player, LD player, DVD player, MD deck, DAT deck, tape deck, Blu-ray disc player, PSX, DVD/VHS COMBO, or DVD/HDD COMBO.

continued

Name	Function
TUNING +/-	Press to scan a station.
D.TUNING	Press to enter direct tuning mode.
◀/▶	Press to replay the previous scene or fast forward the current scene of the DVD player, Blu-ray disc player, DVD/VHS COMBO, or DVD/HDD COMBO.
CATEGORY +/-	Press to select a category for satellite tuner (page 117).
CATEGORY MODE	Press to select the category mode for satellite tuner (page 117).
13 TV CH +^a/-	Press TV (24) and then press TV CH +/- to select preset TV channels.
PRESET +^a/-	Press to <ul style="list-style-type: none"> - select preset stations. - select preset channels of the VCR, satellite tuner, Blu-ray disc player, DVD player, DVD/VHS COMBO, or DVD/HDD COMBO.
14 F1, F2	Press F1 or F2 to select a component. <ul style="list-style-type: none"> • DVD/HDD COMBO <ul style="list-style-type: none"> F1: HDD mode F2: DVD mode • DVD/VHS COMBO <ul style="list-style-type: none"> F1: DVD mode F2: VHS mode
15 BD/DVD TOP MENU	Press to display the menu or on-screen guide of the DVD or Blu-ray disc on the TV screen. Then, use ▲/▼/◀/▶ and ⊕ to perform menu operations.
BD/DVD MENU	Press to display the menu of the DVD or Blu-ray disc on the TV screen. Then, use ▲/▼/◀/▶ and ⊕ to perform menu operations.
TV INPUT	Press TV (24) and then press TV INPUT to select the input signal (TV input or video input).
WIDE	Press TV (24) and then press WIDE to select the wide picture mode.

Name	Function
16 TV VOL +/-	Press TV (24) and then press TV VOL +/- to adjust the TV volume level.
MASTER VOL +/-	Press to adjust the volume level of all speakers at the same time.
17 MUTING	Press to turn off the sound temporarily. Press MUTING again to restore the sound. Press TV (24), and then press MUTING to activate the TV's muting function.
18 DISC SKIP	Press to skip disc of the CD player, VCD player, DVD player, or MD deck (multi-disc changer only).
19 RETURN/EXIT ↶	Press to <ul style="list-style-type: none"> - return to the previous menu. - exit the menu while the menu or on-screen guide of the VCD player, LD player, DVD player, Blu-ray disc player, PSX, DVD/VHS COMBO, or satellite tuner is displayed on the TV screen. To return to the previous menu of Sony TV, press TV (24) and then press RETURN/EXIT ↶.
20 DISPLAY	Press to select information displayed on the display window or TV screen of the VCR, VCD player, LD player, DVD player, CD player, MD deck, Blu-ray disc player, PSX, satellite tuner, DVD/ VHS COMBO, or DVD/HDD COMBO. To select information of Sony TV, press TV (24) and then press DISPLAY.
21 RESOLUTION	Press repeatedly to change the resolution of signals output from the HDMI OUT or COMPONENT VIDEO MONITOR OUT jack (page 92).
22 INPUT MODE	Press to select the input mode when the same components are connected to both digital and analog jacks (page 97).

Name	Function
23 SHIFT	Press to light up the buttons. It changes the remote button function to activate the buttons with pink printing.
24 TV	Press to light up the button. It changes the remote key function to activate the buttons with yellow printing. It also activate the DISPLAY (20), OPTIONS TOOLS (10), HOME/MENU (11), RETURN/EXIT (19), (19), (9), and (9) buttons to perform menu operations for Sony TVs only.
25 THEATER	Press to enjoy optimal image suited for movies and to output the sound from the speakers connected to this receiver automatically. Note This button will only function if your TV is compatible with Theater Mode. For details, refer to the operating instructions supplied with the TV.
26 RM SET UP	Press to set up the remote.

^{a)}The number 5, TV CH +, PRESET + and ► buttons have tactile dots. Use the tactile dots as references when operating the receiver.

^{b)}See the table on page 119 for information on the buttons that you can use to control each component.

Notes

- Some functions explained in this section may not work depending on the model.
- The above explanation is intended to serve as an example only. Therefore, depending on the component, the above operation may not be possible or may operate differently than described.

RM-AAU039

This remote can only be used to operate the receiver. You can control the main functions of the receiver with simple operations using this remote.

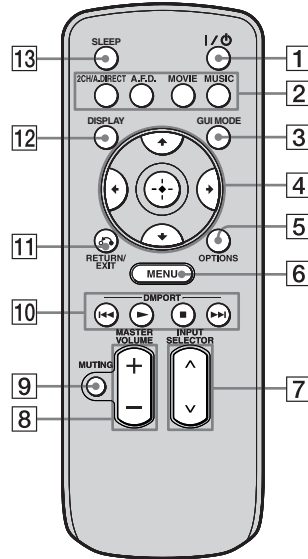

Name	Function
1 I/O (on/standby)	Press to turn a receiver on or off.
2 2CH/A.DIRECT A.F.D. MOVIE MUSIC	Press to select sound field (page 114, 115).
3 GUI MODE	Press to display the GUI menu on the TV screen.
4 	After pressing GUI MODE (3), press ▲/▼/◀/▶ to select the menu items. Then press ⊕ to enter the selection.
5 OPTIONS	Press to display and select items from option menus.

continued

Name	Function
6 MENU	Press to display the menu to operate the receiver.
7 DMPORT	Press to operate component connected to the DIGITAL MEDIA PORT adapter (page 50).
▶	Starts play.
■	Stops play.
◀▶▶▶	Skips tracks.
8 INPUT SELECTOR	Press to select the input source to play back.
9 MASTER VOLUME +/-	Press to adjust the volume level.
10 MUTING	Press to turn off the sound temporarily. Press the button again to restore the sound.
11 RETURN/EXIT ↶	Press to return to the previous menu or exit the menu.
12 DISPLAY	Press to select information displayed in the display window.
13 SLEEP	Press to activate the sleep timer function and the duration which the receiver turns off automatically (page 104).

1: Installing the speakers

This receiver allows you to use a 7.1 channel system (7 speakers and one subwoofer).

Enjoying a 5.1/7.1 channel system

To fully enjoy theater-like multi channel surround sound requires five speakers (two front speakers, a center speaker, and two surround speakers) and a subwoofer (5.1 channel system).

Example of a 5.1 channel speaker system configuration

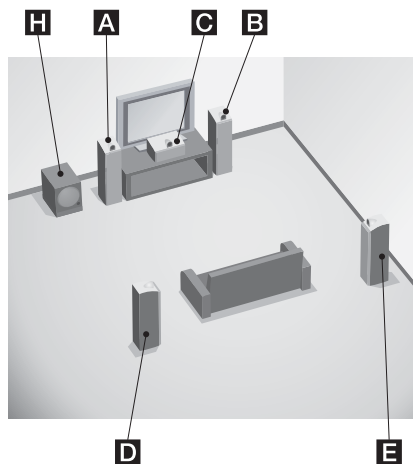

- A** Front speaker (left)
- B** Front speaker (right)
- C** Center speaker
- D** Surround speaker (left)
- E** Surround speaker (right)
- H** Subwoofer

You can enjoy high fidelity reproduction of DVD software recorded sound in the Surround EX format if you connect one additional surround back speaker (6.1 channel system) or two surround back speakers (7.1 channel system.)

Example of a 7.1 channel speaker system configuration

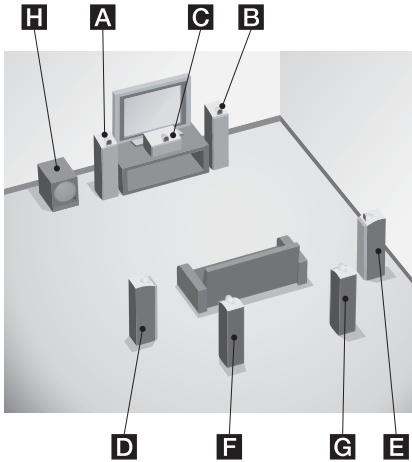

- A** Front speaker (left)
- B** Front speaker (right)
- C** Center speaker
- D** Surround speaker (left)
- E** Surround speaker (right)
- F** Surround back speaker (left)
- G** Surround back speaker (right)
- H** Subwoofer

Tips

- The angle **A** should be the same.

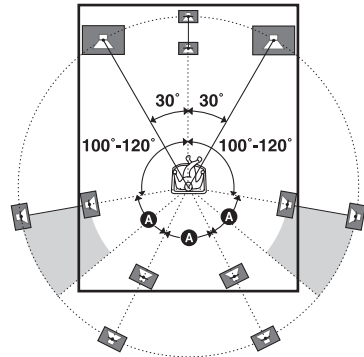

- When you connect a 6.1 channel speaker system, place the surround back speaker behind the listening position.

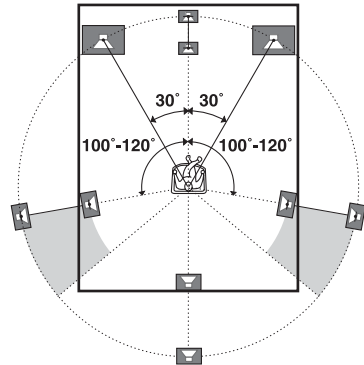

- Since the subwoofer does not emit highly directional signals, you can place it wherever you want.

2: Connecting speakers

Before connecting cords, make sure to disconnect the AC power cord (mains lead).

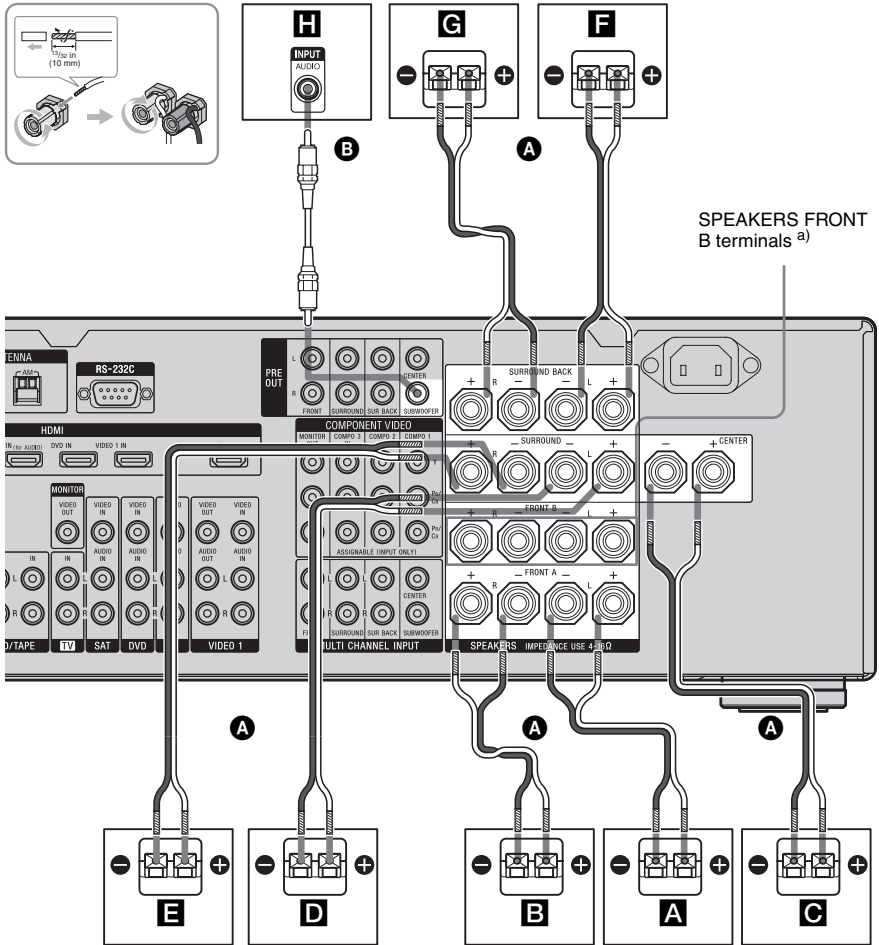

- A** Speaker cords (not supplied)
- B** Monaural audio cord (not supplied)

- A** Front speaker A (left)
- B** Front speaker A (right)
- C** Center speaker
- D** Surround speaker (left)

- E** Surround speaker (right)
- F** Surround back speaker (left)^{b)}
- G** Surround back speaker (right)^{b)}
- H** Subwoofer^{c)}

- a) If you have an additional front speaker system, connect them to the SPEAKERS FRONT B terminals. You can select the front speaker system you want to use with the SPEAKERS switch (OFF/A/B/A+B) on the front panel (page 44).
- b) If you connect only one surround back speaker, connect it to the SPEAKERS SURROUND BACK L terminals.
- c) When you connect a subwoofer with an auto standby function, turn off the function when watching movies. If the auto standby function is set to on, it turns to standby mode automatically based on the level of the input signal to a subwoofer, then sound may not be output.

Notes

- When you connect all the speakers with a nominal impedance of 8 ohms or higher, set “Speaker Impedance” in the Speaker settings menu to “8 ohms”. In other connections, set it to “4 ohms”. For details, see “8: Setting the speakers” (page 42).
- Before connecting the AC power cord (mains lead), make sure that metallic wires of the speaker cords are not touching each other between the SPEAKERS terminals.

Tip

To connect certain speakers to another power amplifier, use the PRE OUT jacks. The same signal is output from both the SPEAKERS terminals and the PRE OUT jacks. For example, if you want to connect just the front speakers to another amplifier, connect that amplifier to the PRE OUT FRONT L and R jacks.

3: Connecting the TV

You can watch the selected input image when you connect the MONITOR OUT or HDMI OUT jack to a TV. You can operate this receiver using a GUI (Graphical User Interface).

It is not necessary to connect all the cables. Connect audio and video cords according to the jacks of your components.

Before connecting cords, make sure to disconnect the AC power cord (mains lead).

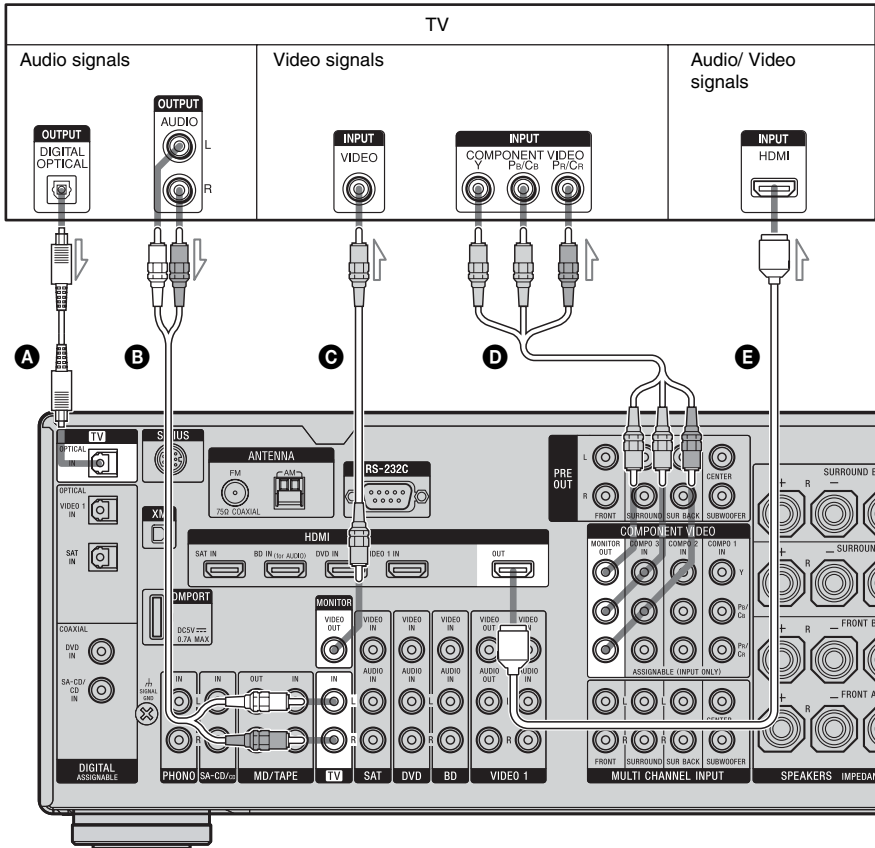

- A** Optical digital cord (not supplied)
- B** Audio cord (not supplied)
- C** Video cord (not supplied)
- D** Component video cord (not supplied)
- E** HDMI cable (not supplied)

We recommend that you use a Sony HDMI cable.

Notes

- Be sure to turn on the receiver when the video and audio signals of a playback component are being output to a TV via the receiver. If the power supply of the receiver is not turned on, neither video nor audio signals will be transmitted.
- When connecting optical digital cords, insert the plugs straight in until they click into place.
- Do not bend or tie optical digital cords.
- Depending on the status of the connection between the TV and the antenna (aerial), the image on the TV screen may be distorted. In this case, place the antenna (aerial) farther away from the receiver.

Tips

- The receiver has a video conversion function. For details, see “Notes on converting video signals” (page 33).
- The sound of the TV is output from the speakers connected to the receiver if you connect the audio output jack of the TV to the TV IN jacks of the receiver. In this configuration, set the sound output jack of the TV to “Fixed” if it can be switched between either “Fixed” or “Variable”.
- All the digital audio jacks are compatible with 32 kHz, 44.1 kHz, 48 kHz, and 96 kHz sampling frequencies.

4a: Connecting the audio components

How to hook up your components

This section describes how to hook up your components to this receiver. Before you begin, refer to “Component to be connected” below for the pages which describe how to connect each component.

After hooking up all your components, proceed to “5: Connecting the antennas (aerials)” (page 35).

Component to be connected		Page
Super Audio CD player, CD player	With digital audio output	20
	With multi channel audio output	22
	With analog audio output only	23
MD deck, Tape deck, Analog disc turntable	With analog audio output only	23
DIGITAL MEDIA PORT adapter		20

Notes

- Before connecting cords, make sure to disconnect the AC power cord (mains lead).
- When connecting optical digital cords, insert the plugs straight in until they click into place.
- Do not bend or tie optical digital cords.

Tip

All the digital audio jacks are compatible with 32 kHz, 44.1 kHz, 48 kHz, and 96 kHz sampling frequencies.

Connecting components with digital audio output jacks

The following illustration shows how to connect a Super Audio CD player, CD player and DIGITAL MEDIA PORT adapter.

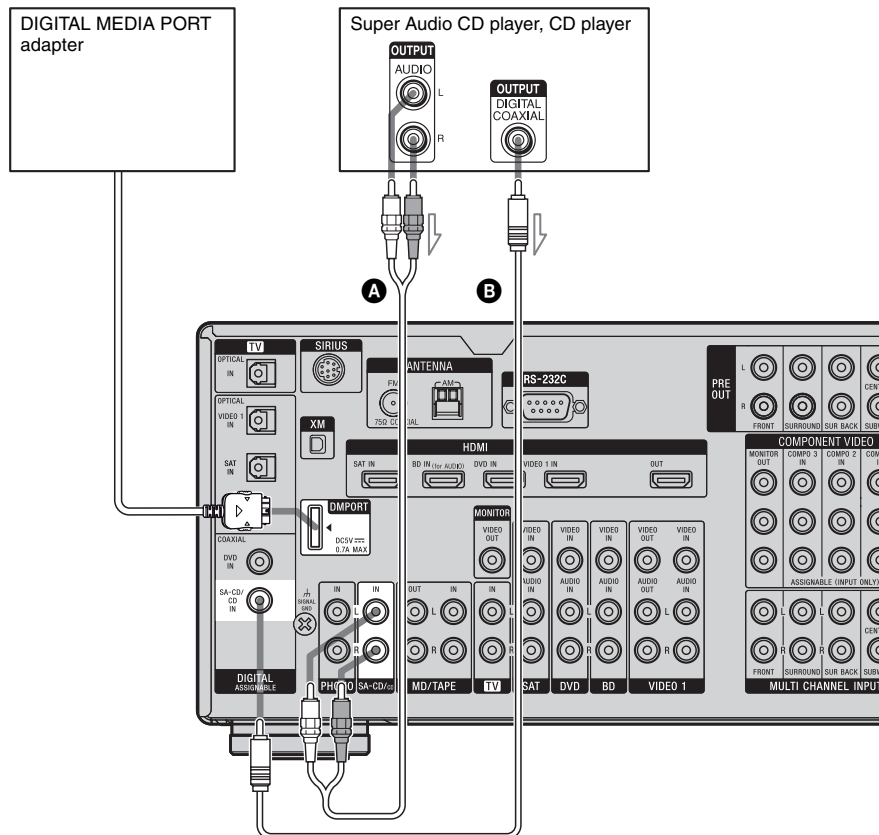

- A** Audio cord (not supplied)
- B** Coaxial digital cord (not supplied)

Notes on connecting DIGITAL MEDIA PORT adapter

- When connecting the DIGITAL MEDIA PORT adapter, be sure the connector is inserted with the arrow mark facing towards the arrow mark on the DMPORT jack.
- Be sure to make DMPORT connections firmly, insert the connector straight in.
- As the connector of the DIGITAL MEDIA PORT adapter is fragile, be sure to handle with care when placing or moving the receiver.
- To disconnect the DIGITAL MEDIA PORT adapter, squeeze the sides of the connector, since the connector is locked in place.

Notes on playing a Super Audio CD on a Super Audio CD player

- When you play a Super Audio CD, connect the player to the MULTI CHANNEL INPUT or SA-CD/CD IN jacks (analog input jack) on this receiver. Refer to the operating instructions supplied with the Super Audio CD player.
- You cannot make digital recordings of a Super Audio CD.

If you want to connect several digital components, but cannot find an unused input

See “Enjoying the sound/images from other inputs” (page 98).

Connecting components with multi channel output jacks

If your DVD or Super Audio CD player is equipped with multi channel output jacks, you can connect them to the MULTI CHANNEL INPUT jacks of this receiver to enjoy multi channel sound. Alternatively, the multi channel input jacks can be used to connect an external multi channel decoder.

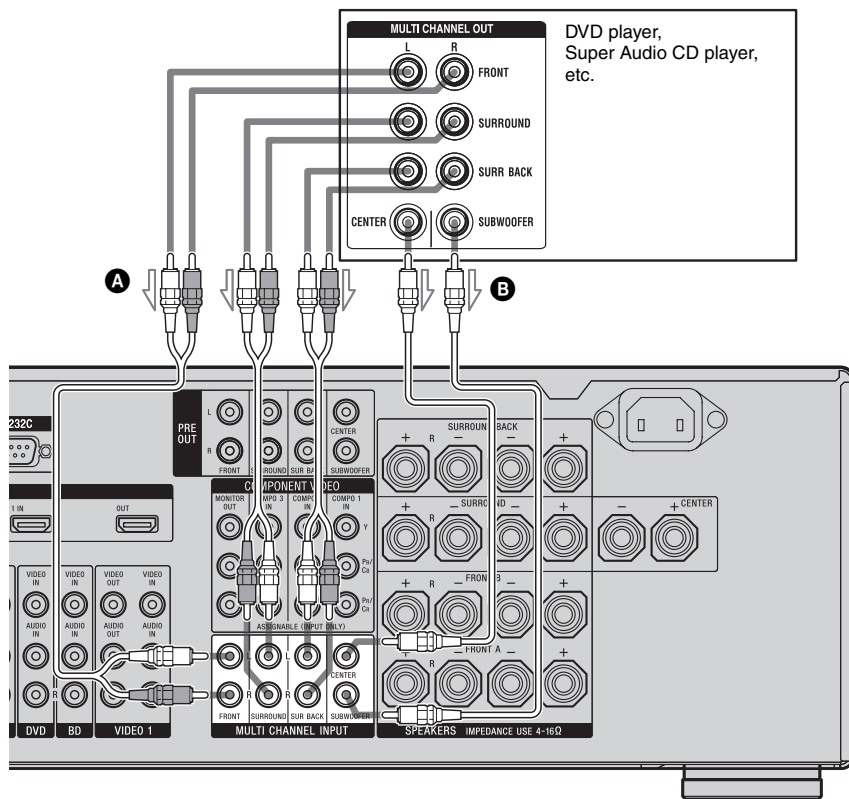

- A** Audio cord (not supplied)
- B** Monaural audio cord (not supplied)

Note

Audio signals input from MULTI CHANNEL INPUT jacks are not output to other audio output jacks. The signals cannot be recorded.

4b: Connecting the video components

How to hook up your components

This section describes how to hook up your components to this receiver. Before you begin, refer to “Component to be connected” below for the pages which describe how to connect each component.

After hooking up all your components, proceed to “5: Connecting the antennas (aerials)” (page 35).

Component to be connected	Page
TV	18
With HDMI jack	25
Blu-ray disc player	28
DVD player	29
Satellite tuner, Set-top box	30
DVD recorder, VCR	31
Camcorder, video game, etc.	31

Video input/output jacks to be connected

The image quality depends on the connecting jack. Refer to the illustration that follows. Select the connection according to the jacks on your components.

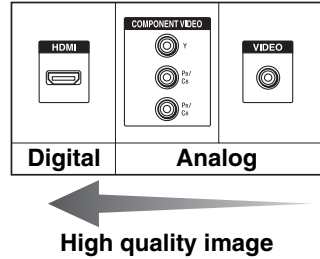

Notes

- Before connecting cords, be sure to disconnect the AC power cord.
- Be sure to turn on the receiver when the video and audio signals of a playback component are being output to a TV via the receiver. If the power supply of the receiver is not turned on, neither video nor audio is transmitted.

Converting video signals

This receiver is equipped with a function for up-converting video signals. For details, see page 32.

Connecting components with HDMI jacks

HDMI is the abbreviated name for High-Definition Multimedia Interface. It is an interface which transmits video and audio signals in digital format.

HDMI features

- A digital audio signals transmitted by HDMI can be output from the speakers and the PRE OUT jacks on this receiver. This signal supports Dolby Digital, DTS and linear PCM.
- This receiver can receive Multi Linear PCM (up to 8 channels) with a sampling frequency of 192 kHz or less with an HDMI connection.
- Analog video signals input to the VIDEO jack or COMPONENT VIDEO jacks can be up-converted as HDMI signals. Audio signals are not output from an HDMI OUT jack when the image is converted.
- This receiver supports High Bitrate Audio (DTS-HD Master Audio, Dolby TrueHD), Deep Color and xvYCC transmission, extended by HDMI ver1.3.
- This receiver supports the Control for HDMI function. For details, see “Control for HDMI” (page 87).

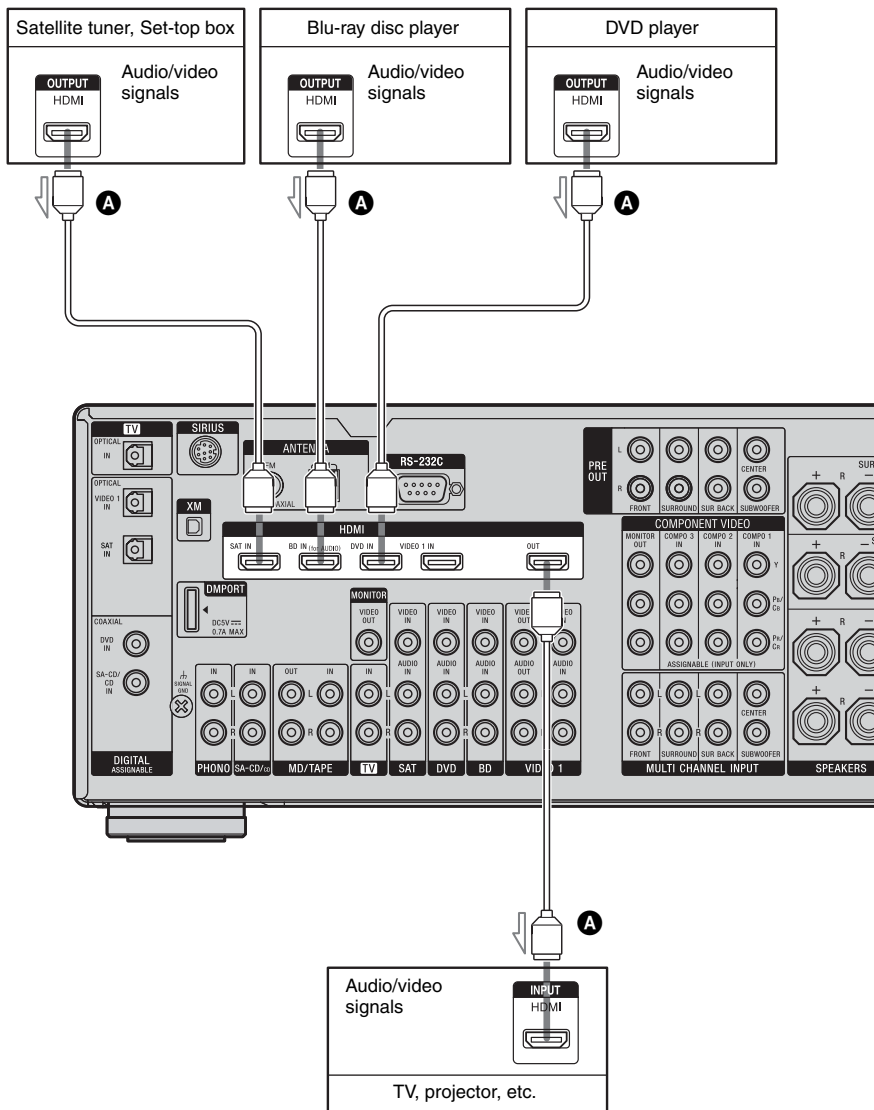

A HDMI cable (not supplied)
 We recommend that you use a Sony HDMI cable.

Notes on connecting cables

- We recommend that you use a Sony HDMI cable.
- We recommend that you use an HDMI cable with the HDMI logo (made by Sony) for the HDMI jack corresponding to high speed (an HDMI version 1.3a, category 2 cable) when you view images or listen to sound during a Deep Color transmission or when you watch a video image of 1080p or higher.
- We do not recommend using an HDMI-DVI conversion cable. When you connect an HDMI-DVI conversion cable to a DVI-D component, the sound and/or the image may not be output. Connect other audio cords or digital connecting cords, then set “Input Assign” in the Input Option menu when the sound is not output correctly.

Notes on HDMI connections

- Check the setup of the connected component if an image is poor or the sound does not come out of a component connected via the HDMI cable.
- An audio signal input to the HDMI IN jack is output from the speaker output jacks, HDMI OUT jack and PRE OUT jacks. It is not output from any other audio jacks.
- A video signal input to the HDMI IN jack can only be output from the HDMI OUT jack. The video input cannot be output from the VIDEO OUT jacks or MONITOR VIDEO OUT jacks.
- The audio and video signals of HDMI input are not output from the HDMI OUT jack while the receiver menu is displayed.
- When you want to listen to the sound from the TV speaker, set “Audio Out” to “TV+AMP” in the HDMI settings menu (page 57). If you cannot play back multi channel audio source, set to “AMP”. However, the sound will not output from the TV speaker.
- DSD signals of Super Audio CD are not input and output.
- Be sure to turn on the receiver when the video and audio of a playback component are being output to a TV via the receiver. If the power supply of the receiver is not turned on, neither video nor audio is transmitted.
- Audio signals (sampling frequency, bit length, etc.) transmitted from an HDMI jack may be suppressed by the connected component. Check the setup of the connected component if an image is poor or the sound does not come out of a component connected via the HDMI cable.
- Sound may be interrupted when the sampling frequency, the number of channels or audio format of audio output signals from the playback component is switched.
- When the connected component is not compatible with copyright protection technology (HDCP), the image and/or the sound from the HDMI OUT jack may be distorted or may not be output. In this case, check the specification of the connected component.
- You can enjoy High Bitrate Audio (DTS-HD Master Audio, Dolby TrueHD), multi channel Linear PCM only with an HDMI connection.
- Set the image resolution of the playback component to more than 720p to enjoy High Bitrate Audio (DTS-HD Master Audio, Dolby TrueHD).
- The image resolution of playback component may need certain settings be made before you can enjoy multi channel Linear PCM. Refer to the operating instructions of the player.
- Not every HDMI component supports all functions that are defined by the specified HDMI version. For example, components that support HDMI, ver. 1.3a, may not support Deep Color.
- Refer to the operating instructions of each component connected for details.

Connecting a Blu-ray Disc Player

The following illustration shows how to connect a Blu-ray Disc Player.

It is not necessary to connect all the cables. Connect audio and video cords according to the jacks of your components.

Note

To input multi channel digital audio from the Blu-ray Disc Player, set the digital audio output setting on the Blu-ray Disc Player. Refer to the operating instructions supplied with the Blu-ray Disc Player.

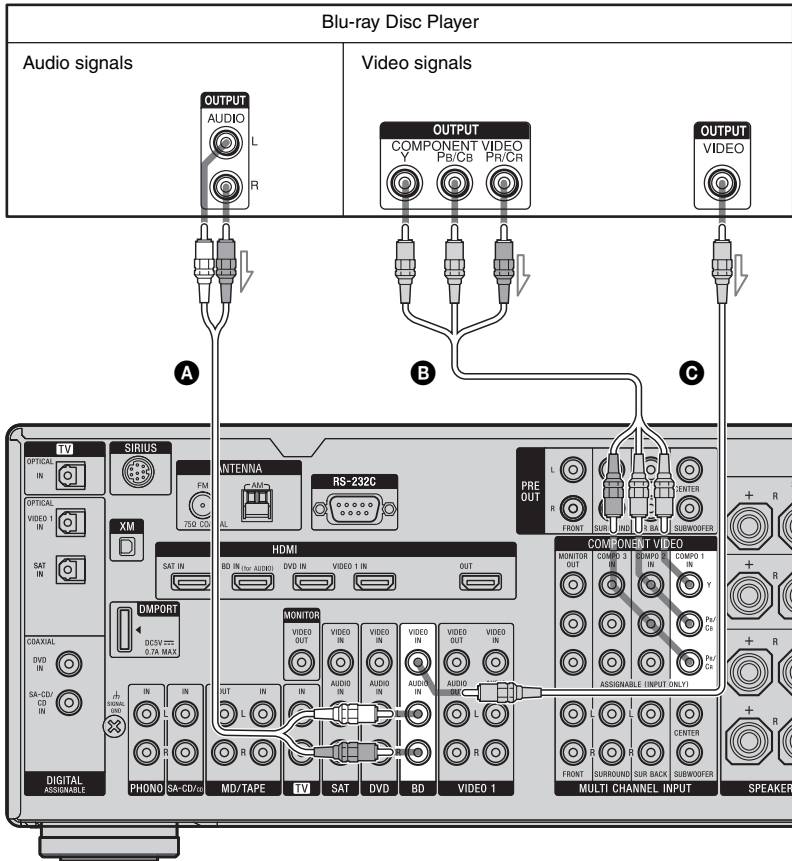

- A** Audio cord (not supplied)
- B** Component video cord (not supplied)
- C** Video cord (not supplied)

Tip

The COMPONENT VIDEO COMPO 1 IN jacks have been assigned to the Blu-ray Disc player. If you connect your Blu-ray Disc player to the COMPONENT VIDEO COMPO 2 or COMPONENT VIDEO COMPO 3 IN jacks, set “Input Assign” in the Input menu.

Connecting a DVD player

The following illustration shows how to connect a DVD player.

It is not necessary to connect all the cables. Connect audio and video cords according to the jacks of your components.

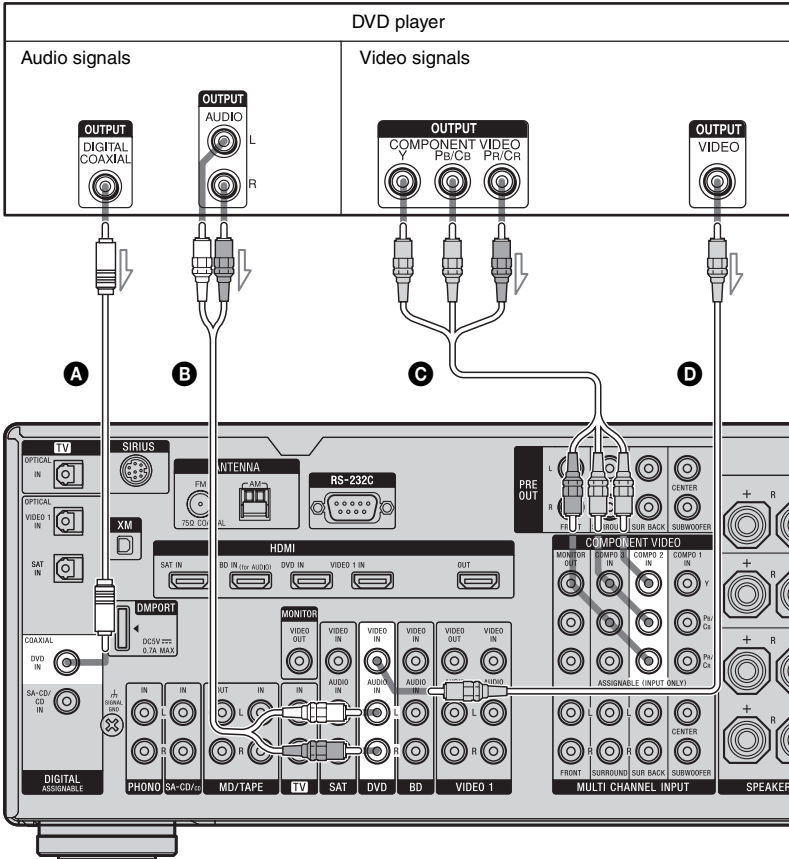

- A** Coaxial digital cord (not supplied)
- B** Audio cord (not supplied)
- C** Component video cord (not supplied)
- D** Video cord (not supplied)

Note

To input multi channel digital audio from the DVD player, set the digital audio output setting on the DVD player. Refer to the operating instructions supplied with the DVD player.

Tips

- All the digital audio jacks are compatible with 32 kHz, 44.1 kHz, 48 kHz, and 96 kHz sampling frequencies.
- The COMPONENT VIDEO COMPO 2 IN jacks have been assigned to the DVD player. If you connect your DVD player to the COMPONENT VIDEO COMPO 1 or COMPONENT VIDEO COMPO 3 IN jacks, set “Input Assign” in the Input menu.

Connecting a satellite tuner, Set-top box

The following illustration shows how to connect a satellite tuner, Set-top box. It is not necessary to connect all the cables. Connect audio and video cords according to the jacks of your components.

Notes

- When connecting optical digital cords, insert the plugs straight in until they click into place.
- Do not bend or tie optical digital cords.

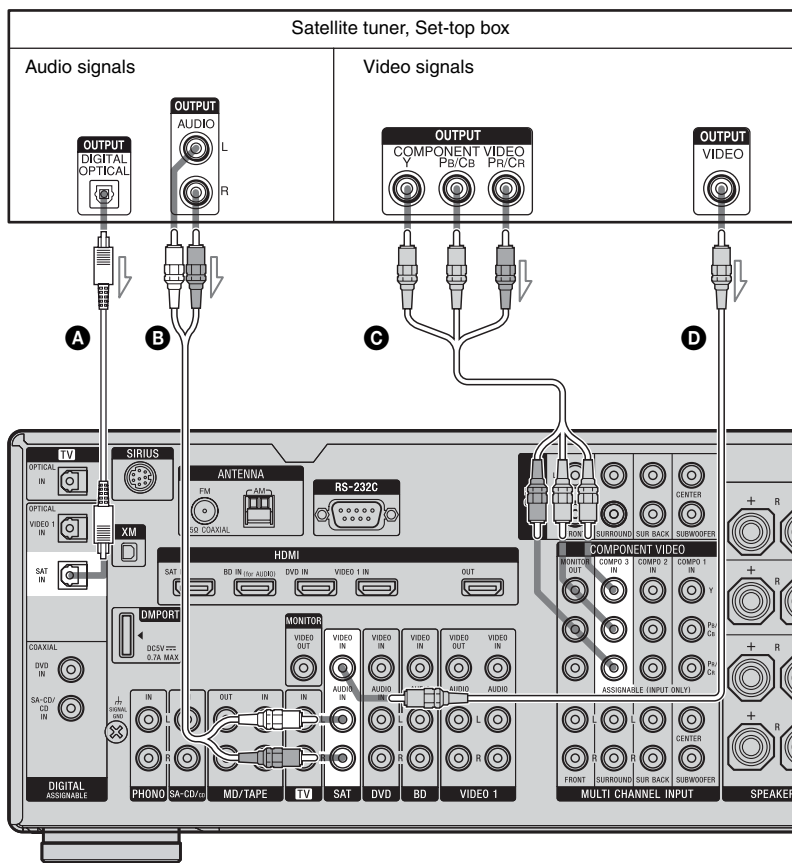

- A** Optical digital cord (not supplied)
- B** Audio cord (not supplied)
- C** Component video cord (not supplied)
- D** Video cord (not supplied)

Tips

- All the digital audio jacks are compatible with 32 kHz, 44.1 kHz, 48 kHz, and 96 kHz sampling frequencies.
- The COMPONENT VIDEO COMPO 3 IN jacks have been assigned to the satellite tuner. If you connect your satellite tuner to the COMPONENT VIDEO COMPO 1 or COMPONENT VIDEO COMPO 2 IN jacks, set “Input Assign” in the Input menu.

Function for conversion of video signals

This receiver is equipped with a function for converting video signals. You can output the video signal after connecting this receiver via the MONITOR OUT or HDMI OUT jack as shown in the illustration.

- Video signals can be output as HDMI video and component video signals.
- Component video signals can be output as HDMI video and video signals.

In the video input/output conversion table of the receiver

Refer to “In the video input/output conversion table classified by the menu settings” (page 34) on the conversion function of images.

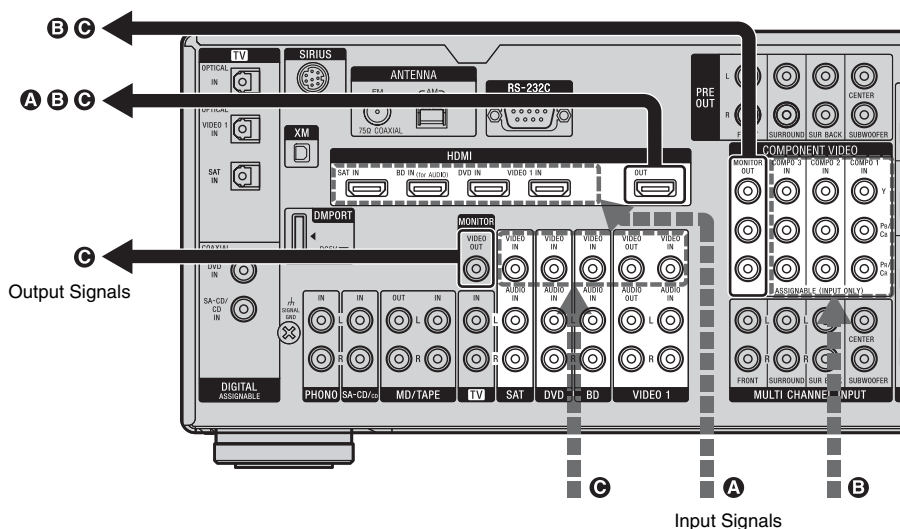

OUTPUT jack \ INPUT jack	HDMI OUT	COMPONENT VIDEO MONITOR OUT	MONITOR VIDEO OUT
HDMI IN A	△	X	X
COMPONENT VIDEO IN B	○	○/△	X
VIDEO IN C	○	○	△

○ : Video signals are up-converted and output through the video converter.

△ : The same type of signal as that of the input signal is output. Video signals are not converted.

X : Video signals are not output.

For details on the video converting function, see “In the video input/output conversion table classified by the menu settings” (page 34).

Notes on converting video signals

- When video signals from a VCR, etc., are converted on this receiver and then output to your TV, depending on the status of the video signal output, the image on the TV screen may appear distorted horizontally or no image may be output.
- HDMI video signals cannot be converted to component video signals and video signals.
- When you play a VCR with an image improvement circuit, such as TBC, the images may be distorted or may not be output. In this case, set the image improvement circuit function to off.
- The resolution of the signals output to the COMPONENT VIDEO MONITOR OUT jacks is converted up to 1080i. The resolution of the signals output to the HDMI OUT jack is converted up to 1080p.
- COMPONENT VIDEO MONITOR OUT jacks have restrictions on resolution when the resolution of video signals protected by copyright technology is converted. Resolution of up to 480p can be output to the COMPONENT VIDEO MONITOR OUT jacks. The HDMI OUT jack has no restriction on resolution.
- Set “Resolution” to “AUTO” or “480/576i” in the Video settings menu to output the video signals from the MONITOR VIDEO OUT and COMPONENT VIDEO MONITOR OUT jack when both are connected.

To display Closed Caption

Set “Resolution” to “DIRECT” in the Video settings menu when receiving a signal that supports Closed Captions.

Use the same kind of cords for the input/output signals.

In the video input/output conversion table classified by the menu settings

For details on “Resolution” menu setting, see “Settings for the video (Video settings menu)” (page 57) and on operating, see “Converting analog video input signals” (page 92).

“Resolution” menu setting	Output from	HDMI OUT jack	COMPONENT VIDEO MONITOR OUT jacks	MONITOR VIDEO OUT jack
	Input signals			
DIRECT	Component video	X	△	X
	Video	X	X	△
AUTO (initial setting)	Component video	○ ^{a)}	○ ^{b)}	X
	Video	○ ^{a)}	○ ^{b)}	△
480/576i	Component video	○ ^{c)}	○	X
	Video	○ ^{c)}	○	△
480/576p	Component video	○	○	X
	Video	○	○	△
720p, 1080i	Component video	○	○ ^{d)}	X
	Video	○	○ ^{d)}	△
1080p	Component video	○	△	X
	Video	○	X	△

○ : Video signals are up-converted and output through the video converter.

△ : The same type of signal as that of the input signal is output. Video signals are not converted.

X : Video signals are not output.

^{a)}The resolution is set automatically, depending on the connected TV.

^{b)}When the TV is connected to jacks other than the HDMI jacks, 480/576i signals are output when “Resolution” is set to “AUTO”.

^{c)}480/576p signals are output even if 480/576i is set.

^{d)}Video signals without copyright protection are output based on the settings menu. Video signals with copyright protection are output as 480p.

Notes

- Video signals are not output from the COMPONENT VIDEO MONITOR OUT jacks when the monitor, etc., is connected to the HDMI OUT jack.
- If you select a resolution that the connected TV does not support in the “Resolution” menu, the images from the TV cannot be output correctly.
- Converted HDMI image output signals do not support “x.v.Color”.
- Converted HDMI image output signals do not support Deep Color.
- When HDMI OUT jack is connected, there is no up-converted video signal output from COMPONENT VIDEO MONITOR OUT jacks. The COMPONENT VIDEO MONITOR OUT jacks have component signal direct output only.

5: Connecting the antennas (aerials)

Connect the supplied AM loop antenna (aerial) and FM wire antenna (aerial).
Before connecting antennas, be sure to disconnect the power cord.

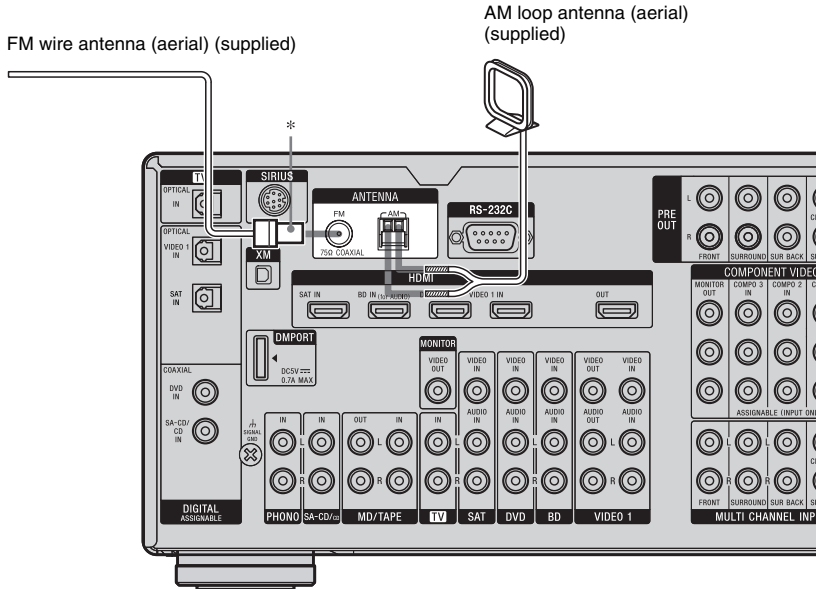

* The shape of the connector varies depending on the area.

Notes

- To prevent noise pickup, keep the AM loop antenna (aerial) away from the receiver and other components.
- Be sure to fully extend the FM wire antenna (aerial).
- After connecting the FM wire antenna (aerial), keep it as horizontal as possible.

6: Preparing the receiver and the remote

Connecting the AC power cord (mains lead)

Connect the supplied AC power cord (mains lead) to the AC INLET terminal on the receiver, then connect the AC power cord (mains lead) to a wall outlet.

Notes

- Before connecting the AC power cord (mains lead), make sure that metallic wires of the speaker cords are not touching each other between the SPEAKERS terminals.
- Connect the AC power cord (mains lead) firmly.

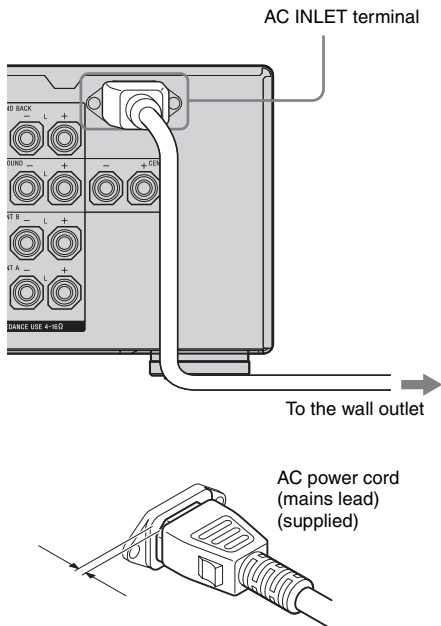

A several space is left between the plug and the rear panel even when the power cord (mains lead) is inserted firmly. The cord is supposed to be connected this way. This is not malfunction.

Performing initial setup operations

Before using the receiver for the first time, initialize the receiver by performing the following procedure. This procedure can also be used to return settings you have made to their factory defaults.

Be sure to use the buttons on the receiver for this operation.

1,2 2,3 2,3

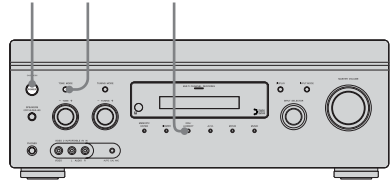

- 1 Press POWER to turn off the receiver.**
- 2 While holding down TONE MODE and 2CH/A.DIRECT, press POWER to turn on the receiver.**
- 3 Release TONE MODE and 2CH/A.DIRECT after a few seconds.**

After "CLEARING" appears on the display for a while, "CLEARED !" appears.

All the settings you have changed or adjusted are reset to the initial settings.

Inserting batteries into the remote

Insert two R6 (size-AA) batteries in the RM-AAP025 remote commander.

Insert two R6 (size-AA) batteries in the RM-AAU039 remote control.

Observe the correct polarity when installing batteries.

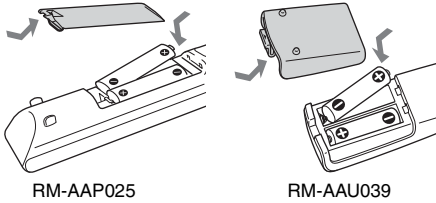

Notes

- Do not leave the remote in an extremely hot or humid place.
- Do not use a new battery with old ones.
- Do not mix manganese batteries and other kinds of batteries.
- Do not expose the remote sensor to direct sunlight or lighting apparatuses. Doing so may cause a malfunction.
- If you do not intend to use the remote for an extended period of time, remove the batteries to avoid possible damage from battery leakage and corrosion.
- When you replace the batteries, the programmed remote codes may be cleared. If this happens, program the remote codes again (page 120).

Tip

When the remote no longer operates the receiver, replace all the batteries with new ones.

About the command mode

The receiver and the remote use the same command mode.

If the command modes of the receiver and the remote are different, you cannot use the remote to operate the receiver.

If the command modes of both the receiver and the remote are those of the initial setting (AV SYSTEM 2), it is not necessary to reset them. You can switch the command mode (AV SYSTEM 1 or AV SYSTEM 2) of the receiver and the remote. If both the receiver and the other Sony component respond to the same remote command, switch the command mode of either the component or the receiver to another command mode so that the component does not respond to the same remote command as the receiver.

To switch the command mode of the receiver

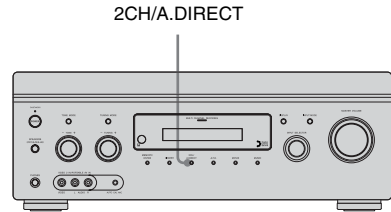

Turn on the receiver while pressing 2CH/A.DIRECT.

When the command mode is set to “AV2”, “C. MODE AV2” appears on the display.

When the command mode is set to “AV1”, “C. MODE AV1” appears on the display.

To switch the command mode of the RM-AAP025 remote

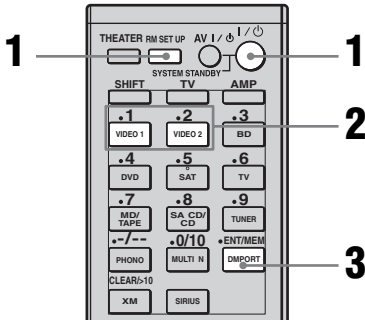

- 1** Press I/⏻ while pressing RM SET UP. The RM SET UP button flashes and the SHIFT button indicator lights up.
- 2** Press 1 or 2 while the RM SET UP button is flashing. When you press 1, the command mode is set to AV SYSTEM 1. When you press 2, the command mode is set to AV SYSTEM 2.
- 3** Press ENT/MEM when the RM SET UP button lights up. The RM SET UP button flashes twice, then the command mode setting process is completed.

To switch the command mode of the RM-AAU039 remote

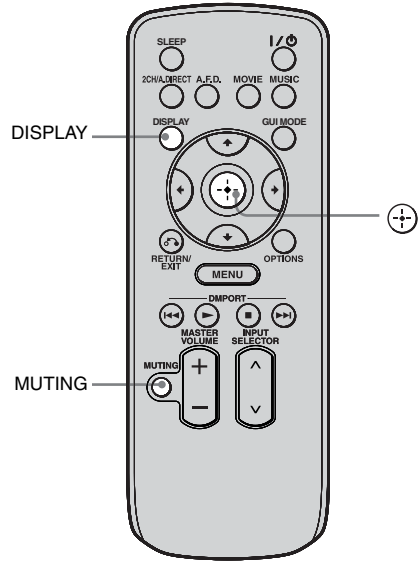

Press and hold DISPLAY, then press MUTING and  at the same time.

7: Operating the receiver using the GUI (Graphical User Interface)

You can change the display mode of the receiver menu to the screen mode using the following procedures. In the screen mode, “GUI MODE” appears in the display window of the receiver.

By using the GUI menu, you can make various settings and adjustments.

For details, see “Operating without connecting to the TV” (page 106) if you are not going to use a GUI menu.

Note

GUI menu does not appear on the TV screen when you have connected your TV to MONITOR VIDEO OUT jack.

Displaying the GUI menu on the TV screen

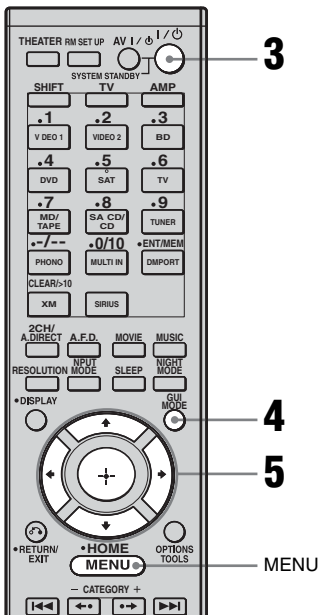

- 1** **Connect a TV to this receiver.**
For details, see “3: Connecting the TV” (page 18).
- 2** **Turn on the TV.**
- 3** **Press I/O to turn on the receiver.**
- 4** **Press GUI MODE repeatedly to select “GUI ON”.**
“GUI MODE” appears on the display window of the receiver and the GUI menu appears on the TV screen. Press MENU if the GUI menu does not appear on the TV screen.
- 5** **Press \uparrow/\downarrow repeatedly to select a menu you want, then press \oplus or \rightarrow .**

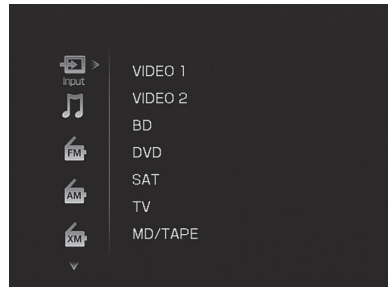

Overview of the menus

The following menu items are available in each settings menu.

Input

Selects the input to the receiver.

For details on each input, see “Selecting a component” (page 50).

Music

You can enjoy sound and image from component connected the DIGITAL MEDIA PORT adapter.

For details on Music function, see “Selecting an operation screen to operate the component connected to the DIGITAL MEDIA PORT adapter” (page 93).

FM/AM/XM/SIRIUS

You can listen to the radio using the receiver.

For details on Tuner operation, see “Tuner Operations” (page 73).

Settings

You can use Settings menu to set and adjust this receiver.

Auto Calibration

You can use the Auto Calibration settings menu to adjust the speakers automatically.

For details, see “9: Calibrating the appropriate speaker settings automatically (Auto Calibration)” (page 44).

Speaker

You can use the Speaker settings menu to adjust the speakers manually for the current position, and to set the speaker impedance.

For details, see “Setting the speaker impedances” (page 42) and “Adjusting the speaker settings manually” (page 66).

Surround

You can use the Surround settings menu to select the sound field you want for your listening pleasure. For details on adjusting the parameters, see “Enjoying a pre-programmed sound field” (page 59).

EQ

You can use the EQ settings menu to adjust the equalizer. For details, see “Adjusting the equalizer” (page 72).

Audio

For details on adjusting the audio using the Audio settings menu, see “Settings for the audio (Audio settings menu)” (page 56).

Video

For details on adjusting the video using the Video settings menu, see “Settings for the video (Video settings menu)” (page 57).

HDMI

You can use the HDMI settings menu to operate components connected to the HDMI jacks. For details on adjusting the relevant parameters, see “Settings for HDMI (HDMI settings menu)” (page 57).

System

For details on adjusting the system using the System settings menu, see “Settings for the system (System settings menu)” (page 58).

Navigating through GUI menus

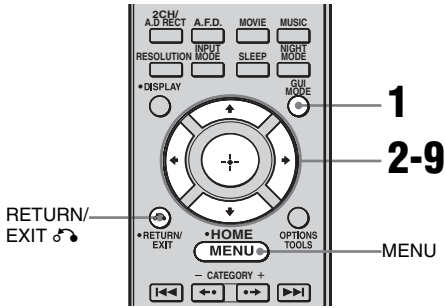

- 1 Press GUI MODE repeatedly to select “GUI ON”.

“GUI MODE” appears on the display window of the receiver and the GUI menu appears on the TV screen. Press MENU if the GUI menu does not appear on the TV screen.

- 2 Press \uparrow/\downarrow repeatedly to select a menu you want.

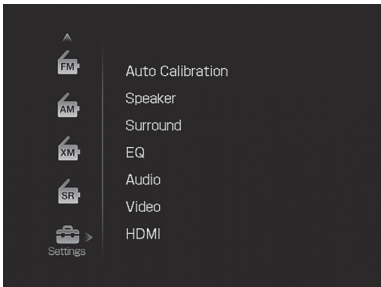

- 3 Press \oplus or \rightarrow to enter the menu.

The menu item list appears on the TV screen.

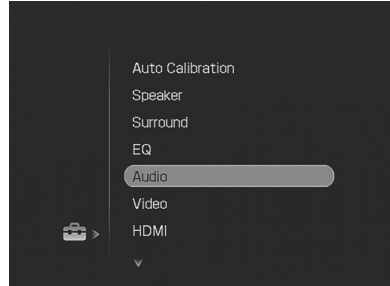

- 4 Press \uparrow/\downarrow repeatedly to select the menu item you want to adjust.

- 5 Press \oplus or \rightarrow to enter the menu item.

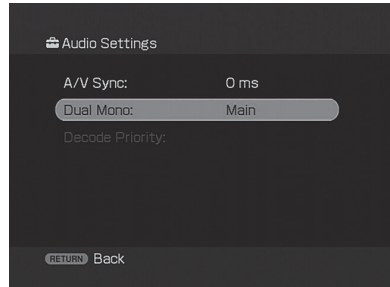

- 6 Press \uparrow/\downarrow repeatedly to select the parameter you want to adjust.

- 7** Press **+** or **→** to enter the parameter.

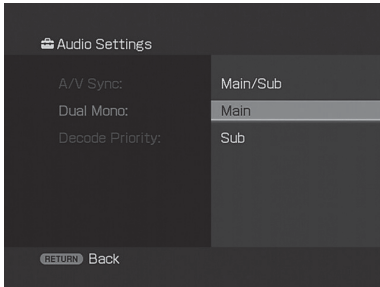

- 8** Press **↑/↓** repeatedly to select the setting you want.
- 9** Press **+** to enter the setting.
- 10** Repeat steps 2 to 9 to make other settings.

To return to the previous screen

Press RETURN/EXIT .

To exit the menu

Press MENU.

To exit “GUI MODE”

Press GUI MODE repeatedly to select “GUI OFF”.

8: Setting the speakers

Setting the speaker impedances

Set the appropriate speaker impedance for the speakers you are using.

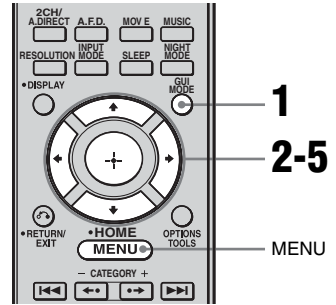

- 1** Press GUI MODE to select “GUI ON”.
“GUI MODE” appears on the display window of the receiver and the GUI menu appears on the TV screen. Press MENU if the GUI menu does not appear on the TV screen.
- 2** Press **↑/↓** repeatedly to select “Settings”, then press **+** or **→**.
The Settings menu list appears on the TV screen.
- 3** Press **↑/↓** repeatedly to select “Speaker”, then press **+** or **→**.

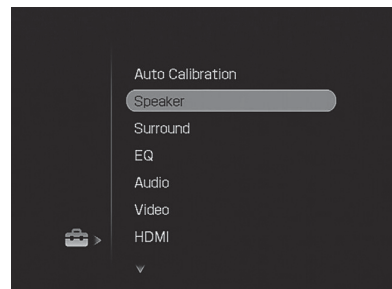

- 4** Press **↑/↓** repeatedly to select **“Speaker Impedance”**, then press **⊕** or **➔**.

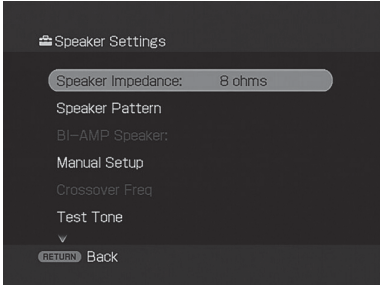

- 5** Press **↑/↓** repeatedly to select **“4 ohms”** or **“8 ohms”** depending on the speakers you are using, then press **⊕**.

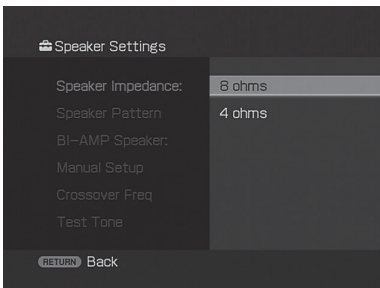

Notes

- If you are not sure of the impedances of the speakers, refer to the operating instructions supplied with your speakers. (This information is often on the back of the speaker.)
- When you connect all speakers with a normal impedance of 8 ohms or higher, set “Speaker Impedance” to “8 ohms”. When connecting other types of speakers, set it to “4 ohms”.
- When you connect front speakers to both the SPEAKERS A and B terminals, connect the speakers with a normal impedance of 8 ohms or higher.
 - When you connect speakers with impedance of 16 ohms or higher in both “A” and “B” configuration:
Set “Speaker Impedance” to “8 ohms” in the Speaker settings menu.
 - For other types of speakers in other configurations:
Set “Speaker Impedance” to “4 ohms” in the Speaker settings menu.

Selecting the front speakers

You can select the front speakers you want to drive.

Be sure to use the buttons on the receiver for this operation.

SPEAKERS (OFF/A/B/A+B)

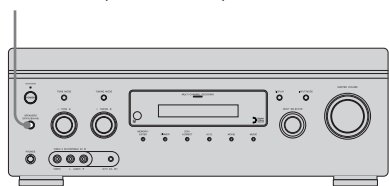

Press SPEAKERS (OFF/A/B/A+B) repeatedly to select the front speaker system you want to drive.

To select	Light up
The speakers connected to the SPEAKERS FRONT A terminals.	SP A
The speakers connected to the SPEAKERS FRONT B terminals.	SP B
The speakers connected to both the SPEAKERS FRONT A and B terminals (parallel connection).	SP A + B

To turn off the speaker output

Press SPEAKERS (OFF/A/B/A+B) repeatedly until the “SP A”, “SP B” and “SP A + B” indicators on the display window do not light up.

“ALL OFF” appears in the display window for a while. No audio signals are output from any speaker terminals.

Note

You cannot switch the front speaker system by pressing SPEAKERS (OFF/A/B/A+B) when the headphones are connected.

9: Calibrating the appropriate speaker settings automatically (Auto Calibration)

The DCAC (Digital Cinema Auto Calibration) function allows you to perform automatic calibration, such as checking the connection between each speaker and the receiver, adjusting the speaker level, and measuring the distance of each speaker from your seating position automatically. Refer also to “Quick Setup Guide” supplied with the receiver.

Before you perform the Auto Calibration

Before you perform the Auto Calibration, set up and connect the speakers (page 14).

- The AUTO CAL MIC jack is used for the supplied optimizer microphone only. Do not connect other microphones. Doing so may damage the receiver and the microphone.
- During the measurement, the sound that comes out of the speakers is very loud. The volume of the sound cannot be adjusted. Pay attention to the presence of children or to the effect on your neighborhood.
- Perform the measurement in a quiet environment to avoid the effect of noise and get a more accurate measurement.
- If there are any obstacles in the path between the optimizer microphone and the speakers, the calibration cannot be performed correctly. Remove any obstacle from the measurement area to avoid measurement error.
- When you use a bi-amplifier connection, set “BI-AMP Speaker” to “ON” in the Speaker settings menu before you perform Auto Calibration.

Notes

- The Auto Calibration function does not work if
 - SPEAKERS (OFF/A/B/A+B) is set to off.
 - headphones are connected.
- If the muting function has been activated before you perform Auto Calibration, the muting function will be set to off automatically.

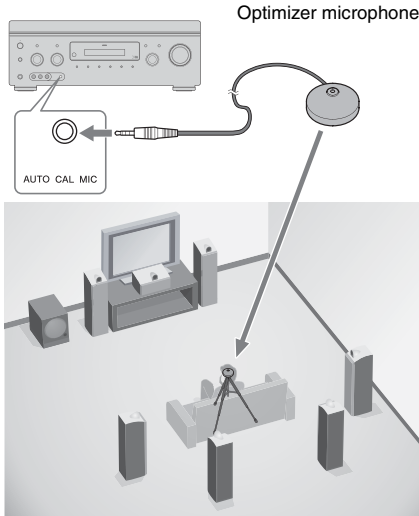

- 1 Connect the supplied optimizer microphone to the AUTO CAL MIC jack.**
- 2 Set up the optimizer microphone.**

Place the optimizer microphone at your seating position. Use a stool or tripod so that the optimizer microphone remains at the same height as your ears.

On setting up the active subwoofer

- When a subwoofer is connected, turn on the subwoofer and turn up the volume beforehand. Turn the MASTER VOLUME knob to just before the mid-point.
- If you connect a subwoofer with the crossover frequency function, set the value to maximum.
- If you connect a subwoofer with an auto standby function, set subwoofer to off (deactivated).

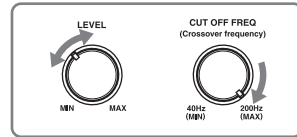

Note

Depending on the characteristics of the subwoofer you are using, the setup distance value may be further away from the actual position.

Using the receiver as a pre-amplifier

You can use the Auto Calibration function when you use the receiver as a pre-amplifier. In this case, the distance value shown on the display may differ from the actual distance value. However, there will be no problems even if you continue to use the receiver with that value.

Performing Auto Calibration

The Auto Calibration function allows you to measure the following:

- Speaker connections^{a)}
- Speaker polarity
- Speaker distance^{a)}
- Speaker size^{a)}
- Speaker level
- Frequency characteristics^{a)b)}

a) The measurement result is not utilized in the following cases.

- The multi channel input is selected.
- “Analog Direct” is being used.

b) The measurement result is not utilized in the following cases.

- Dolby TrueHD signals with a sampling frequency of more than 96 kHz are being received.
- PCM signals with a sampling frequency of more than 96 kHz are being received.

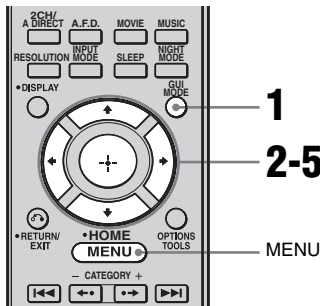

1 Press GUI MODE to select “GUI ON”.

“GUI MODE” appears on the display window of the receiver and the GUI menu appears on the TV screen. Press MENU if the GUI menu does not appear on the TV screen.

2 Press \uparrow/\downarrow repeatedly to select “Settings”, then press \oplus or \rightarrow .

The Settings menu list appears on the TV screen.

3 Press \uparrow/\downarrow repeatedly to select “Auto Calibration”, then press \oplus or \rightarrow .

4 Press \uparrow/\downarrow repeatedly to select “Auto Calibration Start”, then press \oplus or \rightarrow .

5 Press \oplus to select “START”.

6 The measurement starts in five seconds.

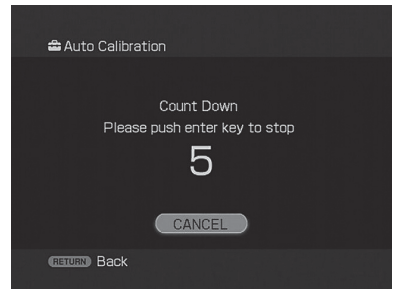

7 Measurement starts.

The measurement process will take approximately 30 seconds with a test tone. Wait until the measurement process completes.

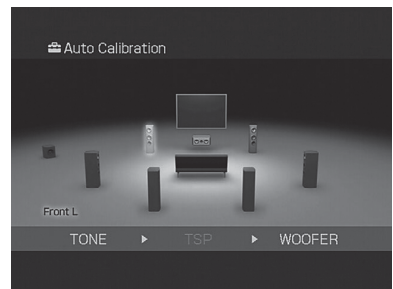

Tip

The measurements may not be performed correctly or Auto Calibration cannot be performed when special speakers, such as dipole speakers are used.

To cancel the measurement

The measurement will be canceled when you do the following:

- Press I/⏻, input buttons or MUTING.
- Press SPEAKERS (OFF/A/B/A+B) on the receiver.
- Change the volume level.
- Connect the headphones.

Confirming/saving the measurement results

1 Confirm the measurement result.

When the measurement ends, a beep sounds.

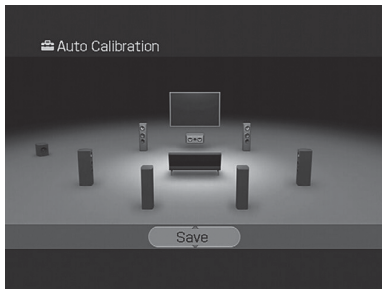

2 Press **▲/▼** to select the item you want, then press **⊕**.

Item	Explanation
Retry	Performs the Auto Calibration again.
Save	Saves the measurement results and exits the setting process.
Warning	Displays warning concerning the measurement results. See “Message list after Auto Calibration measurement” (page 49).
Phase*	Displays the phase of each speaker (in phase/out of phase).
Distance	Displays the measurement result for speaker distance.
Level	Displays the measurement result for speaker level.
Exit	Exits the setting process without saving the measurement results.

* When the speaker(s) is (are) out of the phase, “OUT” is displayed on the TV screen. The “+” and “-” terminals of the speaker may be connected the other way around. However, depending on the speakers, “OUT” appears on the TV screen even though the speakers are connected properly. This is because of the speakers’ specifications. In this case, you can continue to use the receiver.

3 Select “Save” in step 2, then press **⊕** to save the measurement result.

4 Press \uparrow/\downarrow repeatedly to select the Auto Calibration Type, then press \oplus .

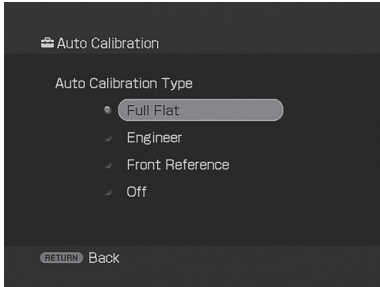

Parameter	Explanation
Full Flat	Makes the measurement of frequency from each speaker flat.
Engineer	Sets the frequency to one that matches that of the Sony listening room standard.
Front Reference	Adjusts the characteristics of all the speakers to match the characteristics of the front speaker.
Off	Sets the Auto Calibration EQ to off.

Tip

The size of a speaker (LARGE/SMALL) is determined by the low characteristics. The measurement results may vary, depending on the position of the optimizer microphone and speakers, and the shape of the room. It is recommended that you follow the measurement results. However, you can change those settings in the Speaker settings menu. Save the measurement results first, then try to change the settings if you want.

Message list after Auto Calibration measurement

Error and warning code	Explanation
Error Code 31	SPEAKERS (OFF/A/B/A+B) is set to off. Set it to others and re-perform the measurement.
Error Code 32	None of the speakers were detected. Make sure that the optimizer microphone is connected properly and reperform the measurement. If the optimizer microphone is connected properly but the error code appears, the optimizer microphone cable may be damaged or improperly connected.
Error Code 33	<ul style="list-style-type: none"> • None of the front speakers are connected or only one front speaker is connected. • The optimizer microphone is not connected. • Either the left or right surround speakers is not connected. • Surround back speakers are connected even though surround speakers are not connected. Connect the surround speaker(s) to the SURROUND terminals. • The surround back speaker is connected only to the SPEAKERS SURROUND BACK R terminals. When you connect only one surround back speaker, connect it to the SPEAKERS SURROUND BACK L terminals.
Warning 40	The measurement has completed. However, the noise level is high. You may be able to perform the measurement properly if you try it again, even though the measurement cannot be performed in all environments. Try to perform the measurement in a quiet environment.
Warning 41	<p>The input from the microphone is too big.</p> <ul style="list-style-type: none"> • It may be too close the distance between the speaker and the microphone. Retry the measurement after setting apart from each other. • It may be that the volume is too big when you use the receiver as a preamp.
Warning 42	<p>The input from the microphone is too big.</p> <ul style="list-style-type: none"> • It may be too close the distance between the speaker and the microphone. Retry the measurement after setting apart from each other. • It may be that the volume is too big when you use the receiver as a preamp.
Warning 43	The distance and position of a subwoofer cannot be detected. This may be caused by noise. Try to perform the measurement in a quiet environment.
NO WARNING	There is no warning information.

•Error Code 31, 32, 33

- 1 When you press \oplus , "RETRY?" appears.
- 2 Press \leftarrow/\rightarrow to select "YES".
- 3 Press \oplus , then follow the instructions from step 1 of "Performing Auto Calibration".

When a warning code appears

If a warning on the measurement result is present, detailed information is displayed.

Press \oplus to return to step 1 of "Confirming/saving the measurement results" (page 47).

Tip

Depending on the position of the subwoofer, the measurement results for polarity may vary. However, there will be no problems even if you continue to use the receiver with that value.

To set Auto Calibration items more precisely

On the Auto Calibration setting menu, press \oplus .

- Position
You can register three patterns as Position 1, 2, and 3, depending on the seating position, listening environment, and measurement conditions.
- Auto Calibration Type
You can select this parameter only when you have performed the Auto Calibration and saved the measurement result.
For details, see the table on page 48.
- Name Input
You can rename the position number. For details, refer to "Naming inputs" (page 96).

Selecting a component

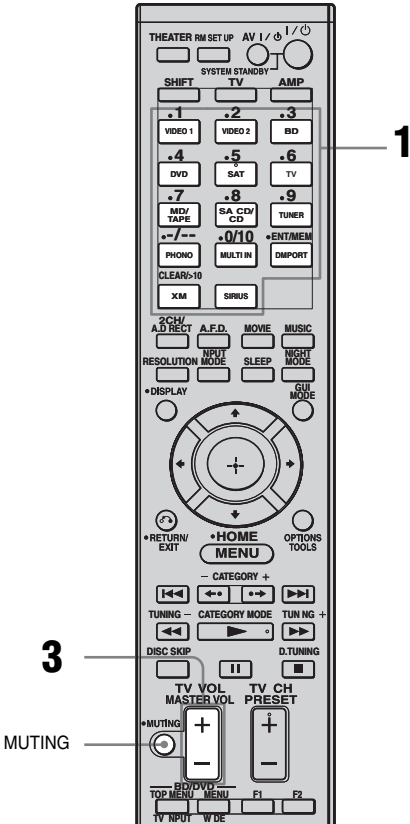

1 Press one of the input buttons to select the component you want.

You can also use INPUT SELECTOR on the receiver or the RM-AAU039 remote. The selected input appears on the display.

Selected input	Components that can be played back
VIDEO 1	VCR, etc., connected to the VIDEO 1 jack.
VIDEO 2	Video camera and TV game, etc., connected to the VIDEO 2 IN/PORTABLE AV IN jack.
BD	Blu-ray disc player, etc., connected to the BD jack.
DVD	DVD player, etc., connected to the DVD jack.
SAT	Satellite tuner, etc., connected to the SAT jack.
TV	TV connected to the TV jack.
MD/TAPE	MD or Tape deck, etc., connected to the MD/TAPE jack.
SA-CD/CD	Super Audio CD or CD player, etc., connected to the SA-CD/CD jack.
TUNER	Built-in radio tuner.
PHONO	Turntable, etc., connected to the PHONO jack.
MULTI IN	Component connected to the MULTI CHANNEL INPUT jack.
DMPORT	Portable audio, etc., connected to the DIGITAL MEDIA PORT adapter connected to the receiver.
XM	XM Mini-Tuner and Home Dock connected to the XM jack.
SIRIUS	SiriusConnect Home tuner connected to the SIRIUS jack.

2 Turn on the component and start playback.

3 Press MASTER VOL +/- to adjust the volume.

You can also use MASTER VOLUME on the receiver.

Tips

- You can adjust the volume differently depending on the speed with which you turn the MASTER VOLUME on the receiver.

To turn the volume up or down quickly: turn the knob quickly.

To make fine adjustment: turn the knob slowly.

- You can adjust the volume differently depending on the length of time you press and hold the MASTER VOL +/- button on the remote.

To turn the volume up or down quickly: press and hold the button.

To make a fine adjustment: press the button and release it immediately.

To activate the muting function

Press MUTING.

The muting function will be canceled when you do the following.

- Press MUTING again.
- Increase the volume.
- Turn off the receiver.

To avoid damaging your speakers

Before you turn off the receiver, be sure to turn down the volume level.

Listening to a Super Audio CD/CD

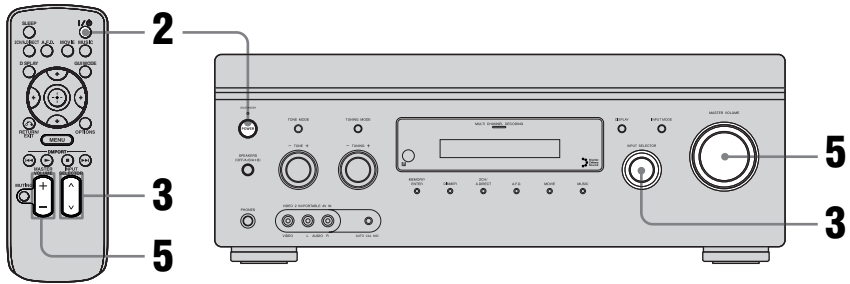

- The operation is described for a Sony Super Audio CD player.
- Refer to the operating instructions supplied with the Super Audio CD player or CD player.



You can select the sound field to suit the music. Refer to page 64 for details.

- 1 Turn on the Super Audio CD player or CD player, then place the disc in the tray.**
- 2 Turn on the receiver.**
- 3 Press INPUT SELECTOR to select “SA-CD/CD”.**
You can also use INPUT SELECTOR on this receiver to select “SA-CD/CD”.
- 4 Play back the disc.**
- 5 Adjust to a suitable volume.**
- 6 After you have finished listening to a Super Audio CD or CD, eject the disc and turn off the receiver and the Super Audio CD player or CD player.**

Watching a DVD/Blu-ray Disc

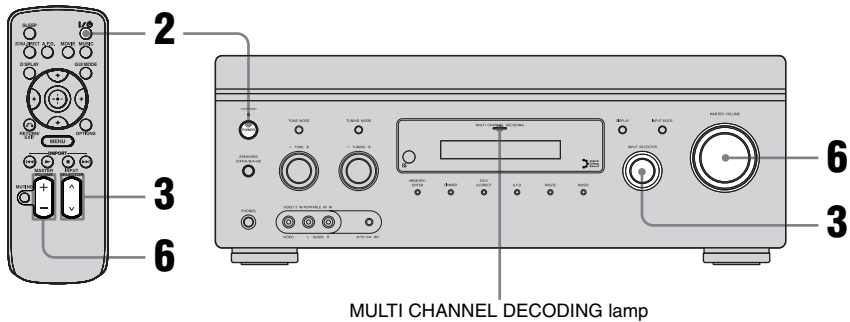

MULTI CHANNEL DECODING lamp



• Refer to the operating instructions supplied with the TV and DVD player or Blu-ray Disc Player.



Select the audio format of the disc to be played, if necessary.



You can select the sound field to suit the movie or the music. Refer to page 64 for details.



Check the following if you cannot listen to the multi channel sound.

- Be sure the sound source corresponds to the multi channel format (the MULTI CHANNEL DECODING lamp on the front panel lights up during playback).
- Be sure this receiver is connected to the DVD player or Blu-ray Disc Player via a digital connection.
- Be sure the digital audio output of the DVD player or Blu-ray Disc Player is set up properly.

- 1 Turn on the TV and DVD player or Blu-ray Disc Player.**
- 2 Turn on the receiver.**
- 3 Press INPUT SELECTOR to select “DVD” or “BD”.**
You can also use INPUT SELECTOR on this receiver to select “DVD” or “BD”.
- 4 Switch the input of the TV so that an image of the DVD or Blu-ray Disc is displayed.**
- 5 Play back the disc.**
- 6 Adjust to a suitable volume.**
- 7 After you have finished watching a DVD or Blu-ray Disc, eject the disc and turn off the receiver, the TV, and the DVD player or Blu-ray Disc Player.**

Enjoying video games

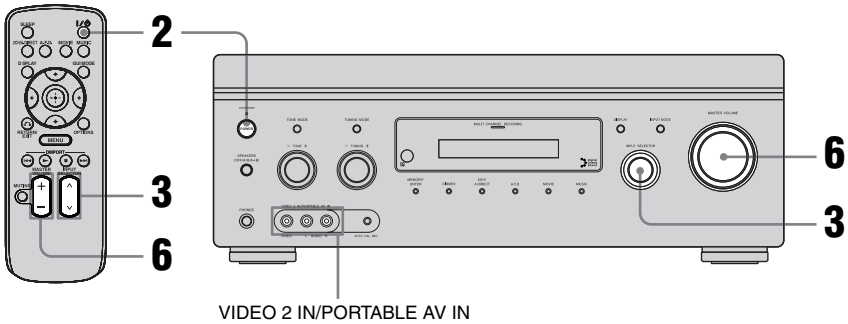

• Refer to the operating instructions supplied with the TV and video game.

- 1** Turn on the TV and video game.
- 2** Turn on the receiver.
- 3** Press **INPUT SELECTOR** to select “VIDEO 2*”.

You can also use **INPUT SELECTOR** on this receiver to select “VIDEO 2*”.

* When you connect a video game to the VIDEO 2 IN/ PORTABLE AV IN jack on the front panel.

- 4** Switch the input of the TV so that an image of the video game is displayed.
- 5** Place the disc in the tray and play it back on the video game.
- 6** Adjust to a suitable volume.
- 7** After you have finished playing a game, eject the disc and turn off the receiver, the TV and the video game.

Watching video

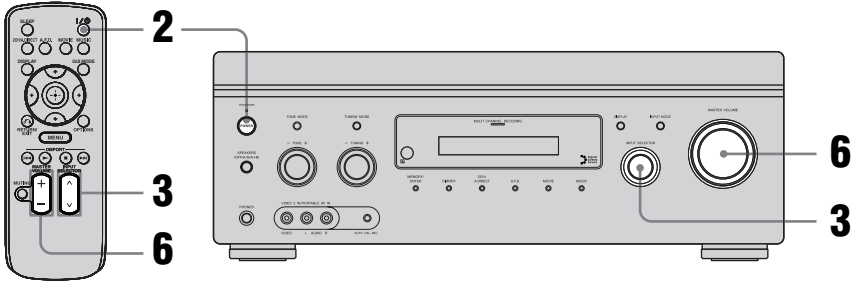

• Refer to the operating instructions supplied with the TV and VCR.

- 1** Turn on the VCR.
- 2** Turn on the receiver.
- 3** Press INPUT SELECTOR to select “VIDEO 1*”.

You can also use INPUT SELECTOR on this receiver to select “VIDEO 1*”.

* When you connect VCR to the VIDEO 1 jack.

- 4** Switch the input of the TV so that an image of the VCR is displayed.
- 5** Play back the tape on the VCR.
- 6** Adjust to a suitable volume.
- 7** After you have finished watching a video, eject the tape and turn off the receiver, the TV and the VCR.

Settings for the audio

(Audio settings menu)

You can use the Audio settings menu to make settings for the audio to suit your preference. Select “Audio” in the Settings menu. For details on adjusting the parameters, see “7: Operating the receiver using the GUI (Graphical User Interface)” (page 39).

Audio settings menu parameters

■ A/V Sync (Synchronizes audio and video output)

Lets you delay the output of audio to minimize the time gap between audio output and visual display. You can adjust the delay from 0 ms to 300 ms in 10 ms steps.

Notes

- This parameter is useful when you use a large LCD or plasma monitor or a projector.
- This parameter is not valid when
 - the multi channel input is selected.
 - “Analog Direct” is being used.

■ Dual Mono (Digital broadcast language selection)

Lets you select the language you want to listen to during a digital broadcast. This feature only functions for Dolby Digital sources.

- Main/Sub
 - Sound of the main language will be output through the front left speaker, and sound of the sub language will be output through the front right speaker simultaneously.
- Main
 - Sound of the main language will be output.
- Sub
 - Sound of the sub language will be output.

■ Decode Priority (Digital audio input decoding priority)

Lets you specify the input mode for the digital signal input to the HDMI IN jacks.

- PCM
 - When signals from the HDMI IN jack are selected, only PCM signals are output from the connected player. To prevent interruption when playback starts, set to “PCM”. When signals in any other format are received, set this item to “AUTO”.
- AUTO
 - Automatically switches the input mode between Dolby Digital, DTS or PCM.

Note

Even when “Decode Priority” is set to “PCM”, the sound may be interrupted at the very beginning of the first track depending on the CD being played back.

Settings for the video

(Video settings menu)

You can use the Video settings menu to make settings for video. Select “Video” in the Settings menu. For details on adjusting the parameters, see “7: Operating the receiver using the GUI (Graphical User Interface)” (page 39).

Video settings menu parameters

■ Resolution (Converting Video signals)

Lets you convert the resolution of analog video input signals.

- DIRECT
- AUTO
- 480/576i
- 480/576p
- 720p
- 1080i
- 1080p

For details on operating, see “In the video input/output conversion table classified by the menu settings” (page 34).

Settings for HDMI

(HDMI settings menu)

You can use the HDMI menu to make the required settings for components connected to the HDMI jack. Select “HDMI” in the Settings menu. For details on adjusting the parameters, see “7: Operating the receiver using the GUI (Graphical User Interface)” (page 39).

HDMI settings menu parameters

■ Control for HDMI

Lets you turn the Control for HDMI function on or off. For details, see “Control for HDMI” (page 87).

■ Audio Out (Setting HDMI audio input)

Lets you set the HDMI audio signals output from the playback component connected to the receiver via an HDMI connection.

- TV+AMP

The sound is output from TV’s speaker and the speakers connected to the receiver.

Notes

- The sound quality of the playback component depends on the TV’s sound quality, such as the number of channels, and the sampling frequency, etc. When the TV has stereo speakers, the sound output from the receiver is also stereo as that of the TV, even if you play back multi channel source.
- When you connect the receiver to an image display component (projector, etc.), sound may not be output from the receiver. In this case, select “AMP”.

- AMP

The HDMI audio signals from the playback component is only output to speakers connected to the receiver. The multi channel sound can be played back as it is.

Note

Audio signals are not output from the TV speakers when “Audio Out” is set to “AMP”.

■ SW Level (Subwoofer level for HDMI)

Lets you set the level of the subwoofer to 0 dB or +10 dB when PCM signals are input via an HDMI connection. You can set the level for each HDMI input independently.

- AUTO
The subwoofer level is automatically set to 0 dB or +10 dB depending on the sampling frequency.
- +10 dB
- 0 dB

Settings for the system (System settings menu)

You can use the System settings menu to customize the settings of the receiver. Select “System” in the Settings menus. For details on adjusting the parameters, see “7: Operating the receiver using the GUI (Graphical User Interface)” (page 39).

System settings menu parameters

■ RS-232C Control

- ON
The receiver can receive commands from the RS-232C port.
- OFF
The receiver does not receive commands from the RS-232C port.

Enjoying Surround Sound

Enjoying a pre-programmed sound field

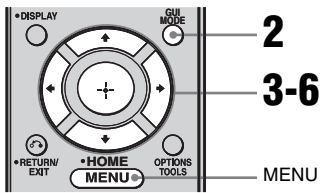

- 1 Start playing a sound source you want to listen to (CD, DVD, etc.).**
- 2 Press GUI MODE to select “GUI ON”.**

“GUI MODE” appears on the display window of the receiver and the GUI menu appears on the TV screen. Press MENU if the GUI menu does not appear on the TV screen.
- 3 Press \uparrow/\downarrow repeatedly to select “Settings”, then press \odot or \rightarrow .**

The Settings menu list appears on the TV screen.
- 4 Press \uparrow/\downarrow repeatedly to select “Surround”, then press \odot or \rightarrow .**
- 5 Press \uparrow/\downarrow repeatedly to select “Sound Field Setup”, then press \odot or \rightarrow .**

- 6 Press \uparrow/\downarrow repeatedly to select the surround sound you want.**

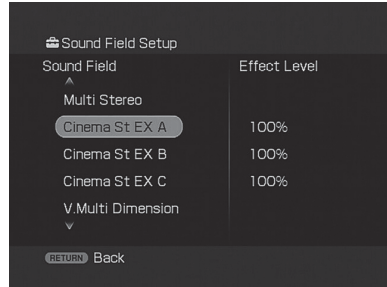

To select enhanced surround mode

- Select “Enhanced Sur Mode” in step 5 above.
- Press \uparrow/\downarrow repeatedly to select the enhanced surround sound you want.
- Press \odot .

Note

The selected enhanced surround mode can only be applied if you have selected “Enhanced Sur” as a sound field in “Sound Field Setup” parameter.

To adjust the effect level

- After you have selected the surround sound in step 6, press \odot or \rightarrow .
- Press \uparrow/\downarrow repeatedly to adjust the effect level, then press \odot or \leftarrow/\rightarrow .

Higher settings apply more surround effect. You can adjust the effect level in 4 steps (50%, 80%, 100%, 150%).

Note

You may not be able to adjust the effect level for some sound field.

Types of 2CH mode

■ 2ch Stereo

The receiver outputs the sound from the front left/right speakers only. There is no sound from the subwoofer.

Standard 2 channel stereo sources completely bypass the sound field processing and multi channel surround formats are downmixed to 2 channel except LFE signals.

Note

No sound is output from the subwoofer in the 2ch Stereo mode. To listen to 2 channel stereo sources using the front left/right speakers and a subwoofer, select “A.F.D. Auto”.

This receiver will generate a low frequency signal for output to the subwoofer when there is no LFE signal, which is a low-pass sound effect output from a subwoofer to a 2 channel signal.

■ Analog Direct

You can switch the audio of the selected input to 2 channel analog input. This function enables you to enjoy high quality analog sources.

When using this function, only the volume and front speaker balance can be adjusted.

When connecting Blu-ray disc players and other next generation HD players

This receiver supports the following audio formats.

Audio format	Maximum number of channels	Connection of the playback component and the receiver	
		COAXIAL/OPTICAL	HDMI
Dolby Digital	5.1ch	○	○
Dolby Digital EX	6.1ch	○	○
Dolby Digital Plus ^{a)}	7.1ch	×	○
Dolby TrueHD ^{a)}	7.1ch	×	○
DTS	5.1ch	○	○
DTS-ES	6.1ch	○	○
DTS 96/24	5.1ch	○	○
DTS-HD High Resolution Audio ^{a)}	7.1ch	×	○
DTS-HD Master Audio ^{a) b)}	7.1ch	×	○
Multi channel Linear PCM ^{a)}	7.1ch	×	○

^{a)} Audio signals are output in another format if the playback component does not correspond to the format. For details, refer to the operating instructions of the playback component.

^{b)} Signals with a sampling frequency of more than 96 kHz are played back at 96 kHz.

Types of A.F.D. mode

The Auto Format Direct (A.F.D.) mode allows you to listen to higher fidelity sound and select the decoding mode for listening to a 2 channel stereo sound as multi channel sound.

A.F.D. mode [appears on TV screen]	Multi channel audio after decoding	Effect
A.F.D. Auto [A.F.D. Auto]	(Detecting automatically)	Presets the sound as it was recorded/encoded without adding any surround effects.
Enhanced Surround Mode [Enhanced Sur]		
Pro Logic II* [PL II]	5-channel signals	Performs Dolby Pro Logic II decoding.
Pro Logic IIx* [PL IIx]	7-channel signals	Performs Dolby Pro Logic IIx decoding.
Neo:6 Cinema [Neo:6 Cinema]	7-channel signals	Performs DTS Neo:6 Cinema mode decoding.
Neo:6 Music [Neo:6 Music]	7-channel signals	Performs DTS Neo:6 Music mode decoding. This setting is ideal for normal stereo sources such as CDs.
Neural-THX® [Neural-THX]	7-channel signals	Next generation of Neural-THX® Surround. In addition to stereo enhancement processing and pure discrete 5.1 surround sound, now capable of full 360° 7.1 surround sound playback from Neural-THX® Surround encoded content.
Multi Stereo [Multi Stereo]	(Multi Stereo)	Outputs 2 channel left/right signals from all speakers. However, sound may not be output from certain speakers depending on the speaker settings.

* Depends on the speaker pattern setting, some enhanced surround mode parameter may not be available.

Notes

- This function does not work in the following cases.
 - The multi channel input is selected.
 - DTS-HD signals with a sampling frequency of more than 48 kHz are being received.
 - Dolby TrueHD signals with a sampling frequency of more than 48 kHz are being received.
 - “Analog Direct” is being used.
- The beginning of the sound stream may be dropped out when Neural-THX® processing is turned on or off.

Tips

- You can identify the encoding format of DVD software, etc., by looking at the logo on the package.
- Dolby Pro Logic IIx decoding is effective, when a multi channel signal is input.

If you connect a subwoofer

This receiver will generate a low frequency signal for output to the subwoofer when there is no LFE signal, which is a low-pass sound effect output to a subwoofer from a 2 channel signal. However, the low frequency signal is not generated for “Neo:6 Cinema” or “Neo:6 Music” when all speakers are set to “LARGE”. In order to take full advantage of the Dolby Digital bass redirection circuitry, we recommend setting the subwoofer’s cut off frequency as high as possible.

Types of music/movie mode

You can take advantage of surround sound simply by selecting one of the receiver's preprogrammed sound fields. They bring the exciting and powerful sound of movie theaters and concert halls into your home.

Sound field for	Sound field [appears on TV screen]	Effect
Movie	Cinema Studio EX A DCS [Cinema St EX A]	Reproduces the sound characteristics of the Sony Pictures Entertainment "Cary Grant Theater" cinema production studio. This is a standard mode, great for watching almost any type of movie.
	Cinema Studio EX B DCS [Cinema St EX B]	Reproduces the sound characteristics of the Sony Pictures Entertainment "Kim Novak Theater" cinema production studio. This mode is ideal for watching science-fiction or action movies with lots of sound effects.
	Cinema Studio EX C DCS [Cinema St EX C]	Reproduces the sound characteristics of the Sony Pictures Entertainment scoring stage. This mode is ideal for watching musicals or films where orchestra music is featured in the soundtrack.
	V.Multi Dimension DCS [V.Multi Dimension]	Creates many virtual speakers from a single pair of actual surround speakers.
Music	Hall [Hall]	Reproduces the acoustics of a classical concert hall.
	Jazz Club [Jazz Club]	Reproduces the acoustics of a jazz club.
	Live Concert [Live Concert]	Reproduces the acoustics of a 300-seat live house.
	Stadium [Stadium]	Reproduces the feeling of a large open-air stadium.
	Sports [Sports]	Reproduces the feeling of sports broadcasting.
	Portable Audio Enhancer [Portable Audio]	Reproduces a clear enhanced sound image from your portable audio device. This mode is ideal for MP3 and other compressed music.
Headphone ^{a)}	Headphone (2ch) [HP(2CH)]	This mode is selected automatically if you use headphones when "2ch Stereo" mode or A.F.D. mode is selected. Standard 2 channel stereo sources completely bypass the sound field processing and multi channel surround formats are downmixed to 2 channels except LFE signals.
	Headphone Theater DCS [HP Theater]	This mode is selected automatically when you use headphones when sound field is selected for movie/music. It allows you to experience a theater-like environment while listening through a pair of headphones.
	Headphone (Multi) [HP MULTI] ^{b)}	This mode is selected automatically if you use headphones when the multi channel input is selected. Outputs the front analog signals from the MULTI CHANNEL INPUT jacks.
	Headphone (Direct) [HP(Direct)]	Outputs the analog signals without processing by the tone, sound field, etc.

^{a)}You can select this sound field mode if the headphones are connected to the receiver.

^{b)}Appears on the display window only.

Notes

- The sound fields for music and movies do not work in the following cases.
 - The multi channel input is selected.
 - DTS-HD signals with a sampling frequency of more than 48 kHz are being received.
 - Dolby TrueHD signals with a sampling frequency of more than 48 kHz are being received.
 - Signals with a sampling frequency of more than 48 kHz are being received.
 - The multi channel PCM signals are received via a HDMI IN jack.
- When one of the sound fields for music is selected, no sound is output from the subwoofer if all the speakers are set to “LARGE” in the Speaker settings menu.

However, the sound will be output from the subwoofer if

 - the digital input signal contains LFE signals.
 - the front and surround speakers are set to “SMALL”.
 - the sound field for movie is selected.
 - “Portable Audio” is selected.

Tips

- You can identify the encoding format of DVD software, etc., by looking at the logo on the package.
- Sound fields with **DCS** marks use DCS technology. See “Glossary” (page 125).
- When the sound field’s **DCS** mark is selected, the Digital Cinema Sound lamp lights up on the display.

To turn off the surround effect for MOVIE/MUSIC

Select “2ch Stereo” or “A.F.D. Auto” in the Surround settings menu.

Resetting sound fields to the initial settings

Be sure to use the buttons on the receiver for this operation.

1,2

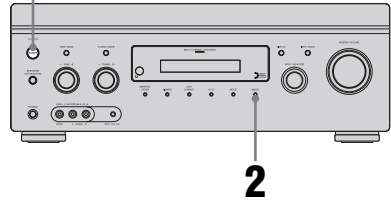

1 Press **POWER** to turn off the receiver.

2 While holding down **MUSIC**, press **POWER**.

“S.F. CLEAR” appears on the display and all sound fields are reset to their initial setting.

Enjoying the surround effect at low volume levels (NIGHT MODE)

This function allows you to retain a theater like environment at low volume levels. This function can be used with other sound fields. When watching a movie late at night, you will be able to hear the dialog clearly even at a low volume level.

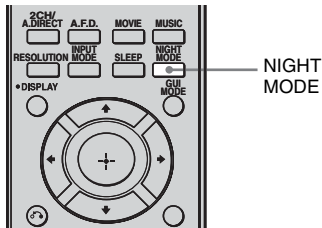

Press NIGHT MODE.

The NIGHT MODE function is activated. The NIGHT MODE is set to on and off as you press NIGHT MODE.

Note

This function does not work in the following cases.

- The multi channel input is selected.
- Dolby TrueHD signals with a sampling frequency of more than 96 kHz are being received.
- PCM signals with a sampling frequency of more than 96 kHz are being received.

Advanced Speakers Setting Up

Adjusting the speaker settings manually

You can adjust each speaker manually. You can also adjust the speaker levels after the Auto Calibration is completed.

Making settings with the Manual Setup menu

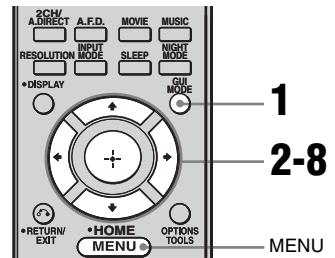

1 Press GUI MODE repeatedly to select “GUI ON”.

“GUI MODE” appears on the display window of the receiver and the GUI menu appears on the TV screen. Press MENU if the GUI menu does not appear on the TV screen.

2 Press ↑/↓ repeatedly to select “Settings”, then press ⊕ or →.

The Settings menu list appears on the TV screen.

3 Press ↑/↓ repeatedly to select “Speaker”, then press ⊕ or →.

- 4** Press \uparrow/\downarrow repeatedly to select “Manual Setup”, then press \oplus or \rightarrow .

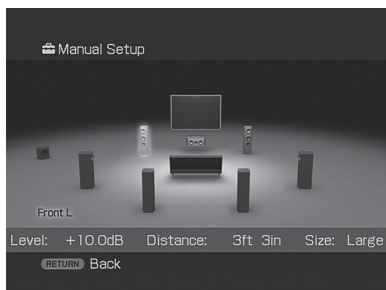

- 5** Press $\uparrow/\downarrow/\leftarrow/\rightarrow$ to select speaker you want to adjust.
- 6** Press \oplus .
- 7** Press \leftarrow/\rightarrow repeatedly to select the parameter you want.
- 8** Press \uparrow/\downarrow repeatedly to adjust the setting.

Manual Setup menu parameters

■ Level (Level of speaker)

You can adjust each speaker's level (center, surround left/right, surround back left/right, subwoofer). You can adjust the level from -20 dB to $+10$ dB in 0.5 dB steps.

For the front left/right speakers, you can adjust the balance on either side. You can adjust the front left level from FL -10.0 dB to FL $+10.0$ dB in 0.5 dB steps. You can also adjust the front right level from FR -10.0 dB to FR $+10.0$ dB in 0.5 dB steps.

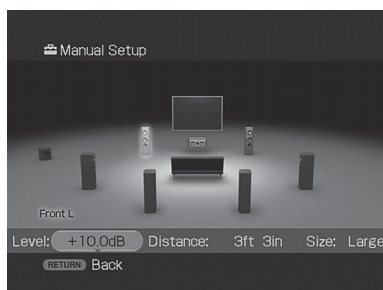

■ Distance (Distance from the seating position to each speaker)

You can adjust the distance from the listening position to each speaker (front left/right, center, surround left/right, surround back left/right, subwoofer).

You can adjust the distance from 1.0 meter to 10.0 meters (3 feet 3 inches to 32 feet 9 inches) in 0.01 meter (1 inch) steps.

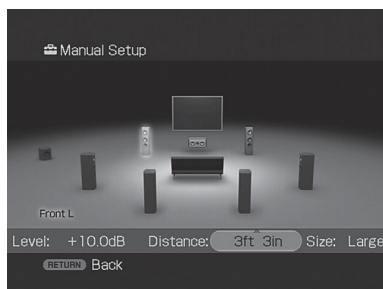

■ Size (Size of each speaker)

You can adjust each speaker's (front left/right, center, surround left/right, surround back left/right) size.

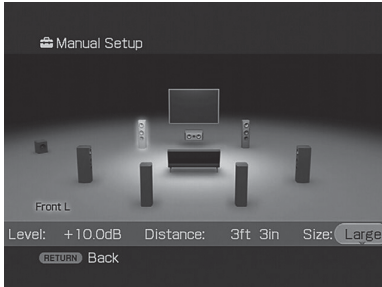

• LARGE

If you connect large speakers that will effectively reproduce bass frequencies, select “LARGE”. Normally, select “LARGE”.

• SMALL

If the sound is distorted, or you feel a lack of surround effects when using multi channel surround sound, select “SMALL” to activate the bass redirection circuitry and output the bass frequencies of each channel from the subwoofer or other “LARGE” speakers.

Note

When one of the sound fields for music is selected, no sound is output from the subwoofer if all the speakers are set to “LARGE”. However, the sound will be output from the subwoofer if the digital input signal contains LFE signals, or if the front or surround speakers are set to “SMALL”, the sound field for movie is selected, or “Portable Audio” is selected.

Tips

- The “LARGE” and “SMALL” settings for each speaker determine whether the internal sound processor will cut the bass signal from that channel.

When the bass is cut from a channel, the bass redirection circuitry sends the corresponding bass frequencies to the subwoofer or other “LARGE” speakers.

However, since bass sound has a certain amount of directionality, it is best not to cut it, if possible.

Therefore, even when using small speakers, you can set them to “LARGE” if you want to output the bass frequencies from that speaker. On the other hand, if you are using a large speaker, but prefer not to have bass frequencies output from that speaker, set it to “SMALL”.

If the overall sound level is lower than you prefer, set all speakers to “LARGE”. If there is not enough bass, you can use the equalizer to boost the bass levels.

- The surround back speakers will be set to the same setting as that of the surround speakers.
- When the front speakers are set to “SMALL”, the center, surround, and surround back speakers are also automatically set to “SMALL”.
- If you do not use the subwoofer, the front speakers are automatically set to “LARGE”.

Making settings with the Speaker Pattern menu

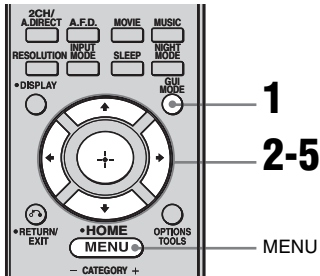

- 5 Press \uparrow/\downarrow repeatedly to select the speaker pattern you want.

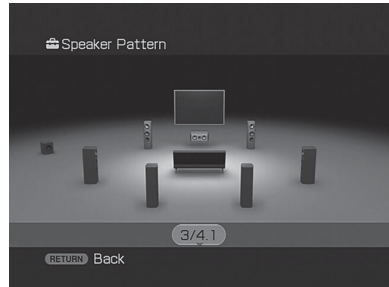

- 1 Press **GUI MODE** repeatedly to select “GUI ON”.

“GUI MODE” appears on the display window of the receiver and the GUI menu appears on the TV screen. Press **MENU** if the GUI menu does not appear on the TV screen.

- 2 Press \uparrow/\downarrow repeatedly to select “Settings”, then press \oplus or \rightarrow .

The Settings menu list appears on the TV screen.

- 3 Press \uparrow/\downarrow repeatedly to select “Speaker”, then press \oplus or \rightarrow .

- 4 Press \uparrow/\downarrow repeatedly to select “Speaker Pattern”, then press \oplus or \rightarrow .

Select “Speaker Pattern” according to the speaker system which you are using. You do not need to select the speaker pattern after Auto Calibration.

Making settings with the Test Tone menu

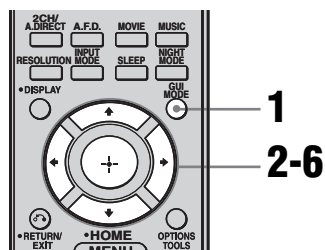

1 Press GUI MODE repeatedly to select “GUI ON”.

“GUI MODE” appears on the display window of the receiver and the GUI menu appears on the TV screen. Press MENU if the GUI menu does not appear on the TV screen.

2 Press \uparrow/\downarrow repeatedly to select “Settings”, then press \oplus or \rightarrow .

The Settings menu list appears on the TV screen.

3 Press \uparrow/\downarrow repeatedly to select “Speaker”, then press \oplus or \rightarrow .

4 Press \uparrow/\downarrow repeatedly to select “Test Tone”, then press \oplus or \rightarrow .

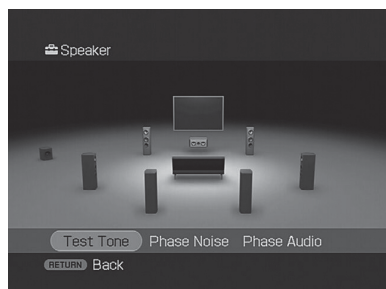

You can select the test tone type.

5 Press \uparrow/\downarrow repeatedly to select the speaker you want to adjust, then press \oplus .

The test tone is output from each speaker in sequence.

6 Adjust the parameter using \uparrow/\downarrow , then press \oplus .

Tips

- To adjust the level of all speakers at the same time, press MASTER VOL +/- . You can also use MASTER VOLUME on the receiver.
- The adjusted value is shown on the display during adjustment.

When a test tone is not output from the speakers

- The speaker cords may not be connected securely. Check to see if they are connected securely and cannot be disconnected by pulling on them slightly.
- The speaker cords may have the short-circuit problem.

When a test tone is output from a different speaker than the speaker displayed on the screen

The speaker pattern to the connected speaker is not set up correctly. Make sure the speaker connection and the speaker pattern match.

Test Tone menu parameters

■ Test Tone

- OFF
- AUTO
The test tone is output from each speaker in sequence.
- FL, CNT, FR, SR, SBR, SBL, SB, SL, SW
You can select which speakers will output the test tone.

■ Phase Noise

- OFF
- FL/FR, FL/CNT, CNT/FR, FR/SL, FR/SR, SR/SL, SR/SBR, SBR/SBL, SR/SB, SBL/SL, SB/SL, SL/FL, FL/SR
Lets you output the test tone sequentially from adjacent speakers.
Some items may not be displayed, depending on the setting of the speaker pattern.

■ Phase Audio

- OFF
- FL/FR, FL/CNT, CNT/FR, FR/SL, FR/SR, SR/SL, SR/SBR, SBR/SBL, SR/SB, SBL/SL, SB/SL, SL/FL, FL/SR
Lets you output front 2 channel source sound (instead of the test tone) sequentially from adjacent speakers.
Some items may not be displayed, depending on the setting of the speaker pattern.

Other parameters of Speaker settings menu

■ BI-AMP Speaker

- OFF
If you have not connected surround back speakers, select “OFF”.
- ON
If you connect front speakers in a bi-amplifier configuration, select “ON”.

Note

Set “BI-AMP Speaker” to “OFF”, then connect the surround back speakers to this receiver when you want to change the connection from a bi-amplifier connection to a surround back speakers connection. Re-set up the speakers after you connect the surround back speakers. Refer to “Auto Calibration” (page 44) or “Manual Setup” (page 67).

■ Crossover Freq (Speaker crossover frequency)

Lets you set the bass crossover frequency of speakers that has been set to “SMALL” in the Speaker menu. Measured speaker crossover frequency is set for each speaker after the Auto Calibration.

The adjusted value is set for each speaker when you adjust the speaker crossover frequency using “Crossover Freq” after the Auto Calibration.

■ D.Range Comp (Dynamic range compressor)

Lets you compress the dynamic range of the sound track. This may be useful when you want to watch movies at low volumes late at night. Dynamic range compression is possible with Dolby Digital sources only.

- MAX
The dynamic range is compressed dramatically.
- STD
The dynamic range is compressed as intended by the recording engineer.
- AUTO
The dynamic range is applied automatically with Dolby TrueHD source or other source is set to “OFF”.
- OFF
The dynamic range is not compressed.

Tips

- Dynamic range compressor lets you compress the dynamic range of the soundtrack based on the dynamic range information included in the Dolby Digital signal.
- “STD” is the standard setting, but it only enacts light compression. Therefore, we recommend using the “MAX” setting. This greatly compresses the dynamic range and lets you view movies late at night at low volumes. Unlike analog limiters, the levels are predetermined and provide a very natural compression.

■ Distance Unit (Distance unit)

Lets you select the unit of measure for setting distances.

- METER
The distance is displayed in meters.
- FEET
The distance is displayed in feet.

Adjusting the equalizer

You can use following parameters to adjust the tonal quality (bass/treble level) of all speakers, and apply them. These settings are applied to all sound fields and for each speaker.

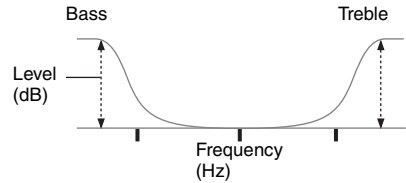

Notes

- This function does not work in the following cases.
 - The multi channel input is selected.
 - Dolby TrueHD signals with a sampling frequency of more than 96 kHz are being received.
 - PCM signals with a sampling frequency of more than 96 kHz are being received.
- If the equalizer is adjusted while the receiver is receiving signals with a sampling frequency of more than 96 kHz, the signals will always be played back at 96 kHz.

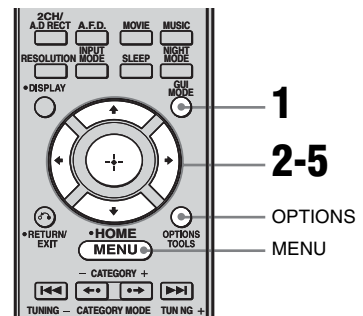

1 Press GUI MODE repeatedly to select “GUI ON”.

“GUI MODE” appears on the display window of the receiver and the GUI menu appears on the TV screen. Press MENU if the GUI menu does not appear on the TV screen.

- Press **▲/▼** repeatedly to select “Settings”, then press **⊕** or **▶**.

The Settings menu list appears on the TV screen.

- Press **▲/▼** repeatedly to select “EQ”, then press **⊕** or **▶**.

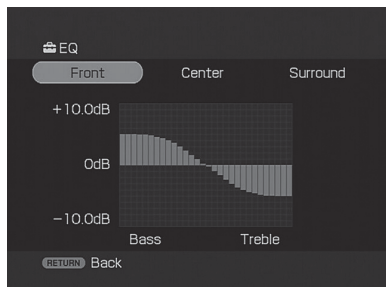

- Choose the speaker you want to adjust using **◀/▶**, then press **⊕**.

- Press **◀/▶** repeatedly to select “Bass” or “Treble”, then press **▲/▼** to adjust the parameter.

Tip

You can adjust the front speaker bass and treble level with TONE MODE and TONE +/- on the receiver.

Tuner Operations

Listening to FM/AM radio

You can listen to FM and AM broadcasts through the built-in tuner. Before operation, make sure you have connected the FM and AM antennas (aerials) to the receiver (page 35).

Tip

The tuning scale for direct tuning is shown below.

- FM band 100 kHz
- AM band 10 kHz*

* The AM tuning scale can be changed (page 135).

Automatic tuning

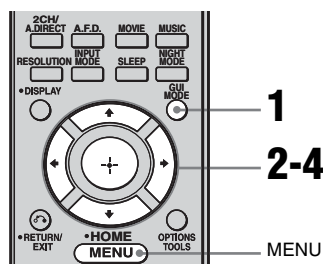

- Press **GUI MODE** repeatedly to select “GUI ON”.

“GUI MODE” appears on the display window of the receiver and the GUI menu appears on the TV screen. Press **MENU** if the GUI menu does not appear on the TV screen.

- Press **▲/▼** repeatedly to select “FM” or “AM”, then press **⊕** or **▶**.

The FM or AM menu list appears on the TV screen.

- 3** Press \uparrow/\downarrow to select “Auto Tuning”, then press \oplus or \rightarrow .



- 4** Press \uparrow/\downarrow .

Press \uparrow to scan from low to high, press \downarrow to scan from high to low.

The receiver stops scanning whenever a station is received.

In case of poor FM stereo reception

- 1 Press OPTIONS.
- 2 Press \uparrow/\downarrow to select “FM Mode”, then press \oplus or \rightarrow .
- 3 Press \uparrow/\downarrow to select “MONO”, then press \oplus .

Direct tuning

You can enter the frequency of a station directly by using the numeric buttons.

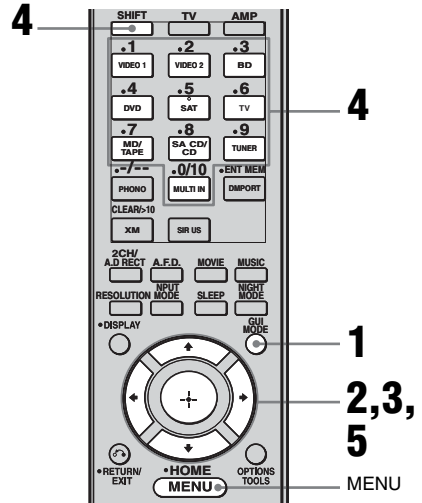

- 1** Press GUI MODE repeatedly to select “GUI ON”.

“GUI MODE” appears on the display window of the receiver and the GUI menu appears on the TV screen. Press MENU if the GUI menu does not appear on the TV screen.

- 2** Press \uparrow/\downarrow repeatedly to select “FM” or “AM”, then press \oplus or \rightarrow .

- 3** Press \uparrow/\downarrow to select “Direct Tuning”, then press \oplus or \rightarrow .

4 Press SHIFT, then press numeric buttons to enter the frequency.

Example 1: FM 102.50 MHz

Select 1 → 0 → 2 → 5

Example 2: AM 1,350 kHz

Select 1 → 3 → 5 → 0

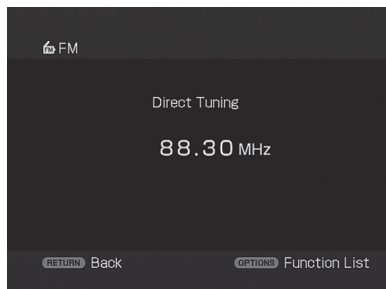

Tip

If you have tuned in an AM station, adjust the direction of the AM loop antenna (aerial) for optimum reception.

5 Press \oplus .

If you cannot tune in a station

"---.--- MHz" appears and then the display returns to the current frequency.

Make sure you have entered the right frequency. If not, repeat step 4. If you still cannot tune in a station, the frequency is not used in your area.

Presetting radio stations

You can preset up to 30 FM and 30 AM stations. Then you can easily tune in the stations you often listen to.

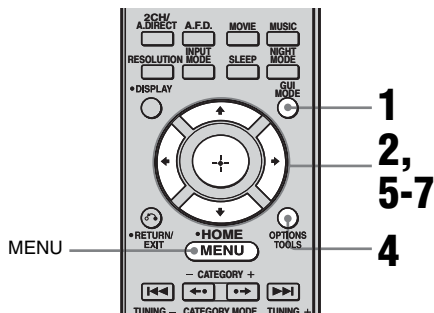

1 Press GUI MODE repeatedly to select "GUI ON".

"GUI MODE" appears on the display window of the receiver and the GUI menu appears on the TV screen. Press MENU if the GUI menu does not appear on the TV screen.

2 Press \uparrow/\downarrow repeatedly to select "FM" or "AM", then press \oplus or \rightarrow .

3 Tune in the station that you want to preset using Automatic Tuning (page 73) or Direct Tuning (page 74).

In case of poor FM stereo reception, switch the FM reception mode (page 74).

4 Press OPTIONS.

5 Press \uparrow/\downarrow to select "Memory", then press \oplus or \rightarrow .

6 Press \uparrow/\downarrow to select a preset number.

7 Press \oplus .

The station is stored as the selected preset number.

- 8 Repeat steps 3 to 7 to preset another station.**

To tune to preset stations

- 1 Repeat steps 1 and 2 of “Presetting radio stations”.
- 2 Press **▲/▼** to select the preset station you want.
You can select a preset station as follows:
 - AM band AM 1 to AM 30
 - FM band FM 1 to FM 30

To name preset stations

- 1 Select a preset station you want to name.
- 2 Press **OPTIONS**, then select “Name Input”.
For details on naming operations, refer to “Naming inputs” (page 96).

Listening to satellite radio

About XM Radio

XM is North America’s number one satellite radio company, offering an extraordinary variety of commercial-free music, plus the best in premier sports, news, talk radio, comedy, children’s and entertainment programming, broadcast in superior digital audio quality coast to coast. For more information, or to subscribe, U.S. customers visit xmradio.com or call XM Listener Care at 1-800-XMRADIO (1-800-967-2346); Canadian customers visit xmradio.ca or call XM Listener Care at 1-877-GETXMSR (1-877-438-9677).

XM Ready® Legal

XM monthly service subscription sold separately. XM Mini-Tuner and Home Dock required (each sold separately) to receive XM service. It is prohibited to copy, decompile, disassemble, reverse engineer, hack, manipulate or otherwise make available any technology or software incorporated in receivers compatible with the XM satellite Radio System. Installation costs and other fees and taxes, including a one-time activation fee may apply. All fees and programming subject to change. Channels with frequent explicit language are indicated with an XL. Channel blocking is available for XM radio receivers by calling 1-800-XMRADIO (U.S. residents) and 1-877-GETXMSR (Canadian residents). Only available in the 48 contiguous United States and Canada. ©2008 XM Satellite Radio Inc. All rights reserved.

XM Ready® Subscription

Once you have installed the XM Mini-Tuner Home Dock, inserted the XM Mini-Tuner, connected the XM Mini-Tuner Home Dock to your XM Ready® audio system, and installed the antenna, you are ready to subscribe and begin receiving XM programming. There are three places to find your eight character XM Radio ID: On the XM Mini-Tuner, on the XM Mini-Tuner package, and on XM Channel 0. Record the Radio ID below for reference.

Note

The XM Radio ID does not use the letters “I”, “O”, “S” or “F”.

Activate your XM Satellite Radio service in the U.S. online at <http://activate.xmradio.com> or call 1-800-XMRADIO (1-800-967-2346). Activate your XM Satellite Radio service in Canada online at <https://activate.xmradio.ca> or call 1-877-GET-XMSR (1-877-438-9677). You will need a major credit card. XM will send a signal from the satellites to activate the full channel lineup. Activation normally takes 10-15 minutes, but during peak busy periods you may need to keep your XM Ready audio system on for up to an hour. When you can access the full lineup on your XM Ready audio system you are done.

SIRIUS Satellite Radio: The Best Radio On Radio

SIRIUS brings all your favorite entertainment including 100% commercial-free music, plus superior sports coverage, uncensored talk and comedy, world-class entertainment, news, weather and more for your car, home or office. Sirius is available in the US for subscribers with addresses in the continental US and is available in Canada for subscribers with a Canadian address. Required subscription plus compatible SiriusConnect Home Tuner with antenna are required and sold separately. SIRIUS Programming is subject to change. Visit sirius.com or siriuscanada.ca for the most complete and up-to-date channel lineup and product information. “SIRIUS” and the SIRIUS dog logo and related marks are trademarks of SIRIUS Satellite Radio Inc. All rights reserved.

To Subscribe to SIRIUS Satellite Radio

Purchase and connect a SiriusConnect Home Tuner to your Sirius Ready home audio system.

You are then ready to activate and subscribe to Sirius by either calling 1.888.539.SIRIUS (7474) or log on to sirius.com (US), siriuscanada.ca (Canada). It is that easy.

Connecting the XM Radio or SIRIUS Satellite Radio

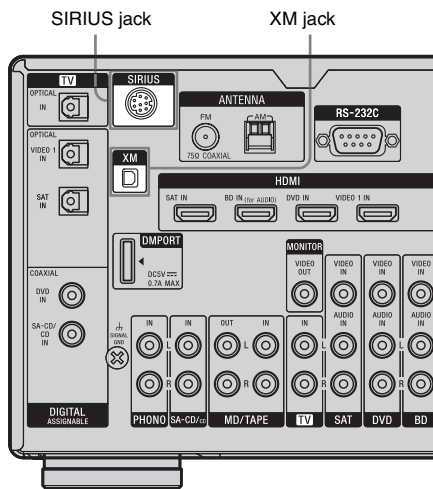

To connect to the XM jack

Before operating the system, connect the XM Mini-Tuner and Home Dock to the XM jack.

Note

To ensure optimal reception of XM's satellite signal, move your antenna to various window locations around your home to see where the best reception will be received. Most XM customers place the antenna in a south-facing window with a clear view to the sky.

To connect to the SIRIUS jack

Connect the SiriusConnect Home tuner. When you use the SiriusConnect Home tuner with this receiver, be sure to connect the AC power adaptor supplied with the tuner to a wall outlet. Keep the SiriusConnect Home tuner, antenna, and AC power adaptor away from the speaker cords and the power cord to avoid picking up noise.

Aiming the XM Radio or SIRIUS antenna (aerial)

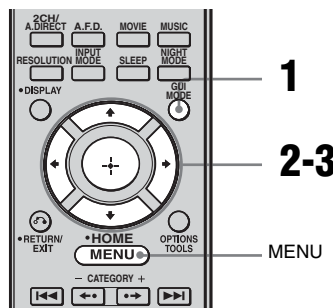







- 1 Press **GUI MODE** repeatedly to select **"GUI ON"**.
 "GUI MODE" appears on the display window of the receiver and the GUI menu appears on the TV screen. Press **MENU** if the GUI menu does not appear on the TV screen.
- 2 Press **↑/↓** repeatedly to select **"XM"** or **"SR"**, then press **⊕** or **➔**.
- 3 Press **OPTIONS**, then press **↑/↓** repeatedly to select **"Antenna Aiming"**, then press **⊕**.

4 While checking the parameter, aim your antenna (aerial) to where the best reception will be received.

For details on the parameter, see “Signal strength” below.

Signal strength

Signal strength	Signal type	
	Satellite	Terrestrial
Good	Y 	Y 
Marginal	Y 	Y 
Weak	Y 	Y 
None	Y	Y

Checking the XM Radio ID or SIRIUS ID number

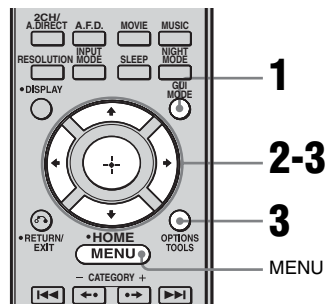

1 Press GUI MODE repeatedly to select “GUI ON”.

“GUI MODE” appears on the display window of the receiver and the GUI menu appears on the TV screen. Press MENU if the GUI menu does not appear on the TV screen.

2 Press \uparrow/\downarrow repeatedly to select “XM” or “SR”, then press \oplus or \rightarrow .

XM

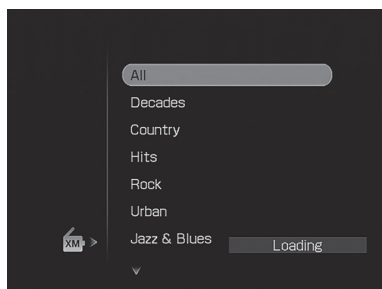

SIRIUS

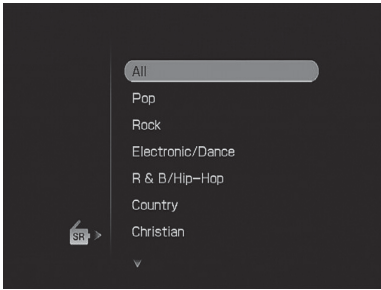

3 Press **OPTIONS**, then press **↑/↓** repeatedly to select “Radio ID” or “Sirius ID”, then press **⊕**.

XM

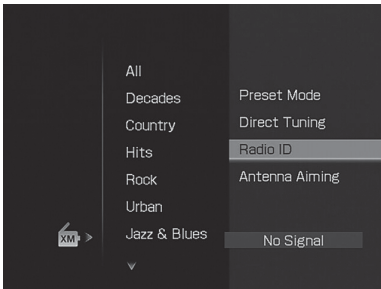

SIRIUS

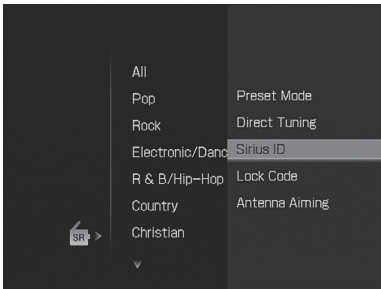

4 Check the **XM Radio ID** or **SIRIUS ID** on the TV screen and write it in the space provided here.

XM Radio ID: _____
 Sirius ID: _____

You can also check the XM Radio ID and SIRIUS ID using the display on the receiver.

Selecting a channel by Category Mode

You can select a channel from one category or all the categories.

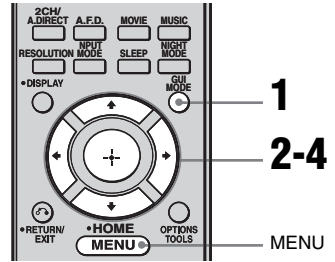

1 Press **GUI MODE** repeatedly to select “GUI ON”.

“GUI MODE” appears on the display window of the receiver and the GUI menu appears on the TV screen. Press **MENU** if the GUI menu does not appear on the TV screen.

2 Press **↑/↓** repeatedly to select “XM” or “SR”, then press **⊕** or **→**.

3 Press **↑/↓** repeatedly to select the category, then press **⊕** or **→**.

- **ALL:** You can select a channel from all the categories.
- **(category name):** You can select a channel from one category.

XM

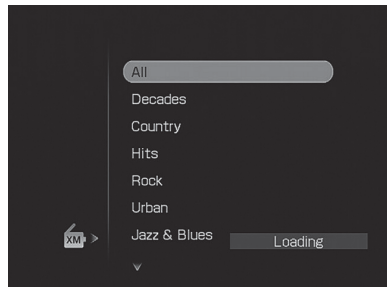

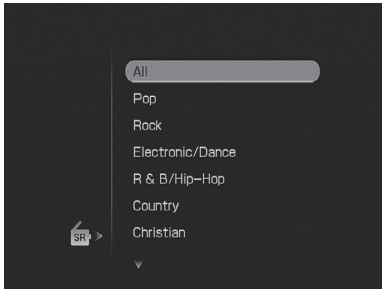

Note

When the “Preset Mode” screen is displayed, press **OPTIONS**, then press **▲/▼** repeatedly to select “Category Mode”.

4 Press **▲/▼** to select the channel, then press **⊕**.

The selected channel is being received.
The channel information is displayed on the TV screen.

Note

When you select a channel in the “Category Mode”, the channel you selected may not be the one in the category you want. This is because one channel may belong to more than one category.

Selecting a channel by inputting the channel number directly

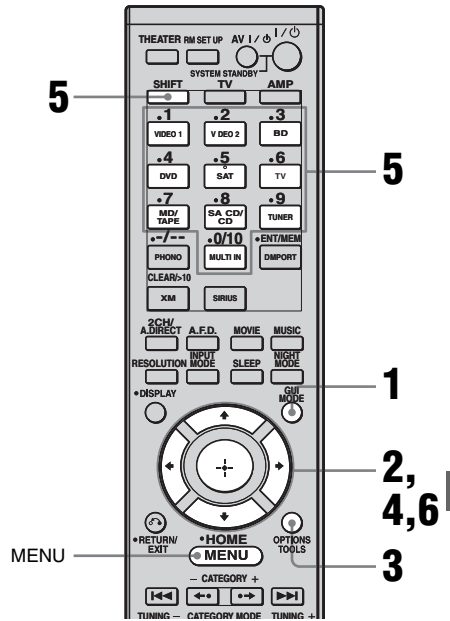

- 1** Press **GUI MODE** repeatedly to select “GUI ON”.
“GUI MODE” appears on the display window of the receiver and the GUI menu appears on the TV screen. Press **MENU** if the GUI menu does not appear on the TV screen.
- 2** Press **▲/▼** repeatedly to select “XM” or “SR”, then press **⊕** or **▶**.
- 3** Press **OPTIONS**.
- 4** Press **▲/▼** to select “Direct Tuning”, then press **⊕**.
- 5** Press **SHIFT**, then press numeric buttons to enter the channel number.
- 6** Press **⊕**.

The selected channel is tune in.

Presetting the channels

You can select the channels you want directly by presetting them using the preset numbers. You can preset up to 30 XM Radio channels and 30 SIRIUS Satellite Radio channels.

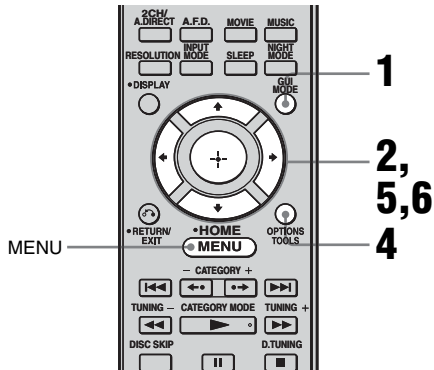

1 Press GUI MODE repeatedly to select “GUI ON”.

“GUI MODE” appears on the display window of the receiver and the GUI menu appears on the TV screen. Press MENU if the GUI menu does not appear on the TV screen.

2 Press \uparrow/\downarrow repeatedly to select “XM” or “SR”, then press \odot or \rightarrow .

3 Select a channel you want to preset using Category Tuning (page 80) or Direct Tuning (page 81).

4 Press OPTIONS.

5 Press \uparrow/\downarrow to select “Memory”, then press \odot or \rightarrow .

6 Press \uparrow/\downarrow repeatedly to select the preset channel you want, then press \odot .

Preset channels from 1 to 30 are available, and a default channel is preset for all the preset channels when you purchase the receiver.

The selected channel is registered as the preset channel you selected in step 3.

7 Repeat steps 3 to 6 to preset another channel.

To select the preset channels

1 Repeat steps 1 and 2 of “Presetting the channels”.

2 Press \uparrow/\downarrow to select the preset number from the preset list, then press \odot . You can select stored preset channels from 1 to 30.

Notes

- The channel information you have preset may be changed if XM Satellite Radio Inc. or SIRIUS Satellite Radio Inc. change their channel programming.
- When the “Category Mode” screen is displayed, press OPTIONS, then press \uparrow/\downarrow to select “Preset Mode”.

Restricting access to specific channels (Parental Lock) (SIRIUS only)

You can restrict access to certain channels using your own lock code. The lock code is set to “0000” as the default.

Change the lock code before you use this function for the first time (see “To change the lock code”).

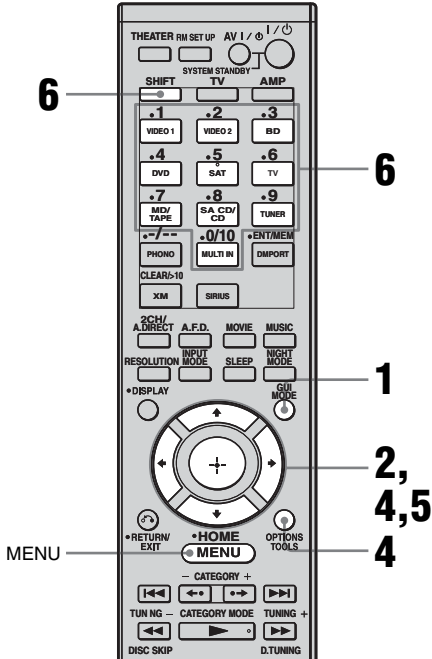

1 Press **GUI MODE** repeatedly to select “GUI ON”.

“GUI MODE” appears on the display window of the receiver and the GUI menu appears on the TV screen. Press **MENU** if the GUI menu does not appear on the TV screen.

2 Press **↑/↓** repeatedly to select “SR”, then press **⊕** or **➡**.

3 Select a channel you want to lock using **Category Tuning** (page 80) or **Direct Tuning** (page 81).

4 Press **OPTIONS**, then press **↑/↓** to select “Parental Lock”, then press **⊕** or **➡**.

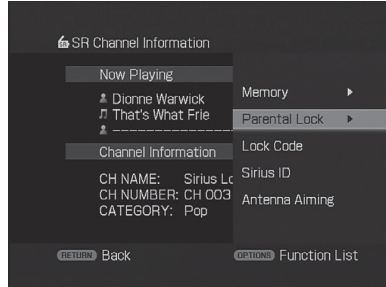

5 Press **↑/↓** repeatedly to select “ON”, then press **⊕**.

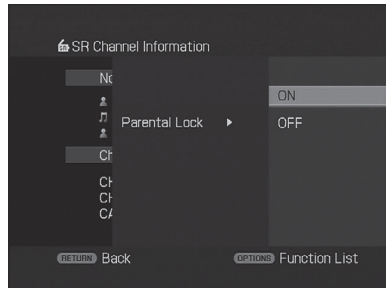

“Enter your 4-digit lock code.” appears.

6 Press SHIFT, then press the numeric buttons to enter your 4-digit lock code.

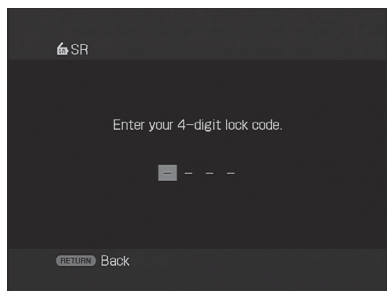

“The channel has been locked.” appears and the Parental Lock is set.

To delete the numbers you have entered, go back to step 4 by pressing RETURN/EXIT , and then repeat the procedure above from step 4.

To change the lock code

- 1 Press \uparrow/\downarrow repeatedly to select “SR”, then press \oplus or \rightarrow .
- 2 Press OPTIONS, then press \uparrow/\downarrow to select “Lock Code”, then press \oplus . “Enter your 4-digit lock code.” appears.
- 3 Press SHIFT, then press the numeric buttons to enter your 4-digit lock code. “Enter a new lock code.” appears.
- 4 Enter a new 4-digit lock code using the numeric buttons. “To confirm, enter your new lock code again.” appears.
- 5 Reenter the new lock code with the numeric buttons. “The lock code has been changed.” appears.

To listen to the locked channels

- 1 Press \uparrow/\downarrow repeatedly to select “SR”, then press \oplus or \rightarrow .
- 2 Select a locked channel you want to listen to using “Direct Tuning” (page 81). “The channel is locked. Enter your 4-digit lock code.” appears.
- 3 Press SHIFT, then press the numeric buttons to enter your 4-digit lock code. The channel is tuned in.

To cancel the Parental Lock

- 1 Press \uparrow/\downarrow repeatedly to select “SR”, then press \oplus or \rightarrow .
- 2 Tune in the channel you want to unlock using “Direct Tuning” (page 81).
- 3 Press OPTIONS, then press \uparrow/\downarrow to select “Parental Lock”, then press \oplus or \rightarrow .
- 4 Press \uparrow/\downarrow repeatedly to select “OFF”, then press \oplus . “Enter your 4-digit lock code.” appears.
- 5 Press SHIFT, then press the numeric buttons to enter your 4-digit lock code. “The channel has been unlocked.” appears and the channel is unlocked.

Notes

- When you select a channel using Category Tuning, locked channels are skipped.
- When the receiver is reset to the factory settings, the lock code returns to the default (0000), but the Parental Lock settings are not removed.
- You cannot preset locked channels. If you set the Parental Lock for a preset channel, the preset information for that channel returns to the default.
- You cannot set the Parental Lock for channel 0 or channel 184.

XM Radio messages list

Message appears on TV screen [Display window]	Explanation	Remedies
Check XM Tuner [XM TUNER]	The XM Mini-Tuner is not installed or not fully seated in the XM Mini-Tuner Home Dock or the XM Mini-Tuner Home Dock is not connected to the receiver.	Confirm the XM Mini-Tuner is fully seated in the dock and check the XM Mini-Tuner and Home Dock cable is connected to the receiver.
Check Antenna [ANTENNA]	The XM antenna is not connected to the XM Mini-Tuner Home Dock or the XM antenna cable is damaged.	Check that the XM antenna is connected to the XM Mini-Tuner and Home Dock securely and check the antenna cable for damage. Replace the XM antenna if the cable is damaged.
CH Unauthorized [UNAUTH]	You have selected an XM channel that is blocked or cannot be received with your XM subscription package.	Consult the latest channel guide at www.xmradio.com (US residents) or www.xmradio.ca (Canadian residents) for the current list of channels. For information on receiving this channel, visit www.xmradio.com (US residents) or www.xmradio.ca (Canadian residents). You can also contact XM Satellite Radio at 1-800-967-2346 (US residents) or 1-877-438-9677 (Canadian residents).
No Signal [NO SIGNAL]	The XM Mini-Tuner is not receiving the XM satellite signal. The XM antenna's view of the satellites may be blocked or the antenna is not properly aimed.	Check the antenna for obstructions and reposition the XM antenna to get a better signal reception. To optimize the antenna position, see "Aiming the XM Radio or SIRIUS Antenna" (page 78). Refer to the operating instructions supplied with the XM Mini-Tuner and Home Dock for antenna installation information.
Loading [LOADING]	The XM Mini-Tuner is acquiring audio or program information from the XM satellite signal. This message can also occur in weak XM signal conditions.	This message should disappear in a few second when the signal is strong. If you often see this message, reposition the XM antenna for better signal reception. To optimize the antenna position, see "Aiming the XM Radio or SIRIUS Antenna" (page 78).
Off Air [OFF AIR]	You have selected an XM channel that is not currently broadcasting.	Check this XM channel later. In the meantime, select another channel.
—	No artist name or song title is available for this selection.	—
CH Unavailable [CH UNAVL]	The selected channel is not available. The channel may have been reassigned to a different channel number. This message may occur initially with a new radio or a radio that has not received XM's signal for an extended period.	Consult the latest channel guide at www.xmradio.com (US residents) or www.xmradio.ca (Canadian residents) for the current channel list. For a new radio or a radio that has not received XM's signal for an extended period, allow the radio to receive the XM satellite signal for at least 5 minutes and then select the channel again.

SIRIUS Satellite Radio message list

Message appears on TV screen [Display window]	Explanation	Remedies
Antenna Error [ANTENNA]	The antenna is not connected properly.	Check the connection between the SiriusConnect Home tuner and the antenna.
Acquiring Signal [ACQUIRING]	The receiving condition is not good.	Try moving the antenna to another location. For details about the antenna location, see the instructions supplied with the SiriusConnect Home tuner.
Call 888-539-SIRI [CAL 888, 539-SIRI]	You have not subscribed for the selected channel.	—
Check Sirius Tuner [SR TUNER]	The SiriusConnect Home tuner is not connected properly.	Check all the connections, and then turn the system on again. Also make sure if the AC adaptor supplied with the SiriusConnect Home tuner is connected to a wall socket.
Invalid CH [INVALID]	You have entered an invalid channel number.	The channel to be tuned-in is void due to the change by the broadcast service, or the receiving condition is not good.
Locked Channel [LOCKED CH]	The selected channel is locked.	—
Sub Updated [SUB UPDT]	The subscription information has been updated.	—
Updating [UPDATING] ■■% Completed (■■ are for integers)	Channel information is being updated.	—
FW Updating [FW UPDT]	The SiriusConnect Home tuner firmware is being updated.	—
-----	There is no text information in the channel.	This is not an error. The text information may not be displayed depending on the system condition, for example, right after the system has received a channel.

Using the Control for HDMI function for “BRAVIA” Sync

To use “BRAVIA” Sync, set the Control for HDMI function as explained below.

By connecting Sony components that are compatible with the Control for HDMI function with an HDMI cable (not supplied), operation is simplified as follows:

- **One-Touch Play:** When you play back a component such as a DVD/Blu-ray disc player, the receiver and the TV are turned on automatically and switched to the appropriate HDMI input.
- **System Audio Control:** While watching TV, you can select to output the sound from the TV speaker or the speakers connected to the receiver.
- **System Power Off:** When you turn off the TV, the receiver and connected components are also turned off simultaneously.

Control for HDMI is a mutual control function standard used by HDMI CEC (Consumer Electronics Control) for HDMI (High-Definition Multimedia Interface).

The Control for HDMI function does not work in the following cases:

- When you connect the receiver to a component which does not correspond with Sony Control for HDMI function.
- When you connect the receiver and components using other than HDMI connection.

We recommend that you connect the receiver to products featuring “BRAVIA” Sync.

Note

Depending on the connected component, the Control for HDMI function may not work. Refer to the operating instructions of the component.

Connecting a TV and other components

Before connecting cords, be sure to disconnect the AC power cord (main lead).

To enjoy TV multi channel surround sound broadcasting

You can listen to TV multi channel surround sound broadcasting from the speakers connected to the receiver.

Connect the OPTICAL output jack of the TV to the TV OPTICAL IN jack of the receiver.

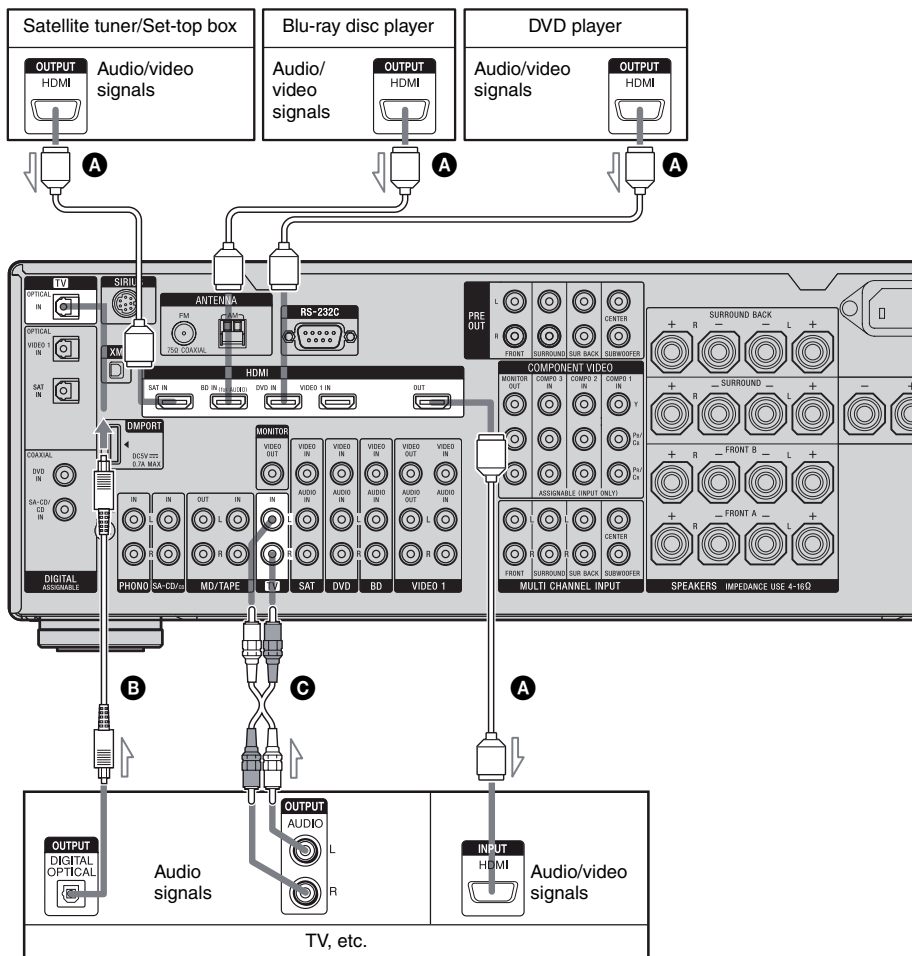

A HDMI cable (not supplied)

We recommend that you use a Sony HDMI cable.

B Optical digital cord (not supplied)^{a)}

C Audio cord (not supplied)^{a)}

^{a)}Connect at least one of the audio cords (**B** or **C**).

Preparing Control for HDMI function

This receiver supports the Control for HDMI-Easy Setting function.

This function is only available for certain types of TV. When you perform the Control for HDMI-Easy Setting from the TV, the Control for HDMI setting on this receiver will automatically change accordingly. During the Control for HDMI-Easy Setting operation, “SCANNING” flashes in the display.

This receiver will automatically change the input to HDMI input. When the setting is completed, “COMPLETE” appears on the display.

For details, refer to the operating instructions of the TV.

If your TV does not support the Control for HDMI-Easy Setting function, do the following procedures. For details on setting the TV and connected components, refer to the operating instructions of the respective components.

- 1** Make sure that the receiver is connected to the TV and components (compatible with Control for HDMI function) via HDMI connection.
- 2** Turn on the receiver, TV and connected components.
- 3** Set the respective Control for HDMI function for the receiver and TV to on. See “To set Control for HDMI” (page 90). When the receiver menu is displayed on the TV screen in the screen mode, press GUI MODE repeatedly to select “GUI OFF” to enter the display mode, then check the TV display image of the component connected to the receiver.
For details on setting the TV, refer to the operating instructions of the TV.
- 4** Select the HDMI input of the receiver and TV to match the HDMI input of the connected component, so that the image from the connected component is displayed.

- 5** Set the Control for HDMI function for the connected component to on.

If the Control for HDMI function for the connected component is already set to on, you do not need to change the setting.

- 6** Repeat steps 4 and 5 for other components that you want to use the Control for HDMI function.

Notes

- If you unplug and reconnect the HDMI cable, be sure to repeat steps 1 to 6 above.
- You cannot perform One-Touch Play and System Audio Control during the Control for HDMI-Easy Setting operation.
- Before you do the Control for HDMI-Easy Setting from the TV, be sure to turn on the TV, connected components and receiver.
- If the playback components cannot function after you have made the settings for Control for HDMI-Easy Setting, check the Control for HDMI setting on your TV.
- If the connected components do not support Control for HDMI-Easy Setting, you need to set the Control for HDMI function for the connected components to on before you perform the Control for HDMI-Easy Setting from the TV.

To set Control for HDMI

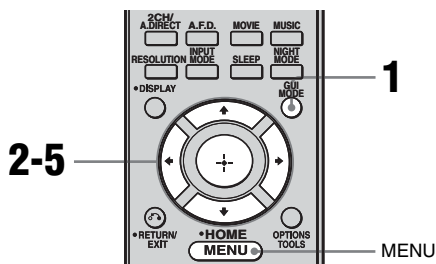

1 Press GUI MODE repeatedly to select “GUI ON”.

“GUI MODE” appears on the display window of the receiver and the GUI menu appears on the TV screen. Press MENU if the GUI menu does not appear on the TV screen.

2 Press \uparrow/\downarrow repeatedly to select “Settings”, then press \odot or \rightarrow .

The Settings menu list appears on the TV screen.

3 Press \uparrow/\downarrow repeatedly to select “HDMI”, then press \odot or \rightarrow .

4 Press \uparrow/\downarrow repeatedly to select “Control for HDMI”, then press \odot or \rightarrow .

5 Press \uparrow/\downarrow repeatedly to select “ON”, then press \odot .

Control for HDMI function is activated.

Watching a DVD

(One-Touch Play)

You can enjoy sound and image from the components connected to the receiver via HDMI connections by a simple operation.

Play back a connected component.

The receiver and the TV are turned on automatically and switched to the appropriate HDMI input.

Watching a DVD by simple operation

You can also select a connected component, such as a DVD/Blu-ray disc player using the TV menu. In this case, the receiver and the TV switch to the appropriate HDMI input.

Note

Depending on the TV, the start of the content may not be output.

Enjoying the TV sound from the speakers connected to the receiver

(System Audio Control)

You can enjoy the TV sound from the speakers connected to the receiver by a simple operation.

You can operate System Audio Control function using the TV menu. For details, refer to the operating instructions of the TV. When System Audio Control function is turned on, the receiver will turn on and switches to the appropriate input automatically.

TV sound is output from the speakers connected to the receiver, and the volume of the TV is minimized simultaneously.

You can also use the System Audio Control function as follows.

- If you turn on the receiver while the TV is turned on, the System Audio Control function will automatically be set to on and the TV sound will output from the speakers connected to the receiver. However, if you turn off the receiver, the sound will output from the TV speakers.
- You can adjust the receiver's volume when you adjust the TV volume.

Notes

- If System Audio Control does not function according to your TV setting, refer to the operating instructions of the TV.
- When "Control for HDMI" is set to "ON", the "Audio Out" settings in the HDMI menu will set automatically depending on the System Audio Control settings.
- When you connect a TV that does not have System Audio Control function, the System Audio Control function does not work.
- If the TV is turned on before turning on the receiver, the TV sound will not be output for a moment.

Turning off the receiver with the TV

(System Power Off)

When you turn the TV off by using the POWER button on the TV's remote, the receiver and the connected components turn off automatically.

You can also use the receiver's remote to turn off the TV.

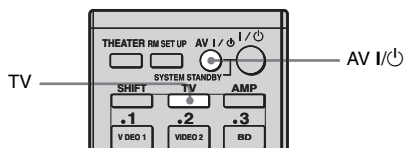

Press TV, then press AV I/O.

The TV, receiver and the components connected via HDMI are turned off.

Notes

- Set the TV Standby Synchro to "ON" before using the System Power Off function. For details, refer to the operating instructions of the TV.
- Depending on the status, the connected components may not be turned off. For details, refer to the operating instructions of the connected components.

Other Operations

Converting analog video input signals

This receiver allows you to convert the resolution of analog video input signals.

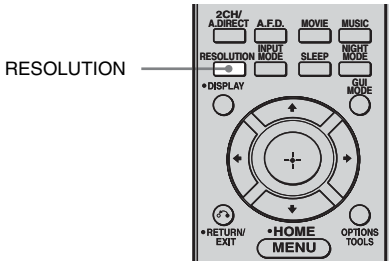

Press RESOLUTION repeatedly.

Each time you press the button, the resolution of the output signals will be changed.

You can also use “Resolution” in the Video settings menu.

Enjoying the DIGITAL MEDIA PORT adapter (DMPORT)

The DIGITAL MEDIA PORT (DMPORT) allows you to enjoy sound from a network system such as a portable audio/video source or computer.

By connecting a DIGITAL MEDIA PORT adapter, you can enjoy sound and image from the connected component on the receiver. For details on connecting the DIGITAL MEDIA PORT adapter, see “Connecting components with digital audio output jacks” (page 20).

Sony offers the following DIGITAL MEDIA PORT adapters:

- TDM-BT1 Bluetooth™ Wireless Audio Adapter
- TDM-NW1/NW10 DIGITAL MEDIA PORT Adapter
- TDM-NC1 Wireless Network Audio Client
- TDM-iP1/iP10/iP50 DIGITAL MEDIA PORT Adapter
- TDM-MP10 DIGITAL MEDIA PORT Adapter

The DIGITAL MEDIA PORT adapter is an optional product.

Notes

- Do not connect an adapter other than the DIGITAL MEDIA PORT adapter.
- Before disconnecting the DIGITAL MEDIA PORT adapter, make sure to turn the receiver off using the remote.
- Do not connect or disconnect the DIGITAL MEDIA PORT adapter while the receiver is turned on.
- Depending on the type of DIGITAL MEDIA PORT adapter, video output may not be possible.
- The DIGITAL MEDIA PORT adapters are available for purchase depending on the area.

Selecting an operation screen to operate the component connected to the DIGITAL MEDIA PORT adapter

You can select an operation screen using the GUI menu, depending on the DIGITAL MEDIA PORT adapter you want to use. For some adapter, such as TDM-BT1 or TDM-NW1, the operation screen is fixed and you cannot change it on the GUI screen.

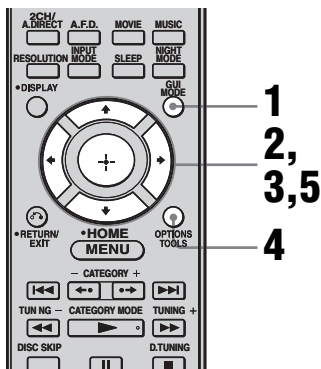

1 Press GUI MODE repeatedly to select “GUI ON”.

“GUI MODE” appears on the display window of the receiver and the GUI menu appears on the TV screen. Press MENU if the GUI menu does not appear on the TV screen.

2 Press \uparrow/\downarrow repeatedly to select “Music”, then press \oplus or \rightarrow .

3 Press \oplus or \rightarrow .

The component connected to the DIGITAL MEDIA PORT adapter is recognized and “DMPORT” on the screen will change to each component’s name. The category of the component connected to DIGITAL MEDIA PORT adapter appears on the TV screen.

4 Press OPTIONS to display “Function List”.

5 Press \uparrow/\downarrow to select “DMPORT Control”.

You can select the following modes in this menu;

- System GUI
This mode is for the TDM-iP1 and TDM-NC1. The list of tracks will be displayed on the GUI screen of the receiver. You can select a track you want and play back it on each GUI screen.
- Adapter GUI
This mode is for the TDM-iP1 and TDM-NC1. The menu of the adapter will be displayed on the TV screen.
- iPod
This mode can be selected only when the TDM-iP1 is connected.

If “DMPORT Control” is not displayed, see the operating instructions supplied with component for details on operating that component.

Operating the component connected to the DIGITAL MEDIA PORT adapter

To operate the TDM-iP1 or TDM-NC1 using the GUI menu of the receiver

- 1** Make sure that “System GUI” is selected in step 5 in “Selecting an operation screen to operate the component connected to the DIGITAL MEDIA PORT adapter” (page 93).
- 2** Select content from the contents list displayed on the GUI screen and play it back.

iPod — Playlists > Playlist > Track
— Artists > Track
— Albums > Album > Track
— Songs > Track
— Genres > Genre > Artist > Album > Track
— Composers > Composer > Track
— Audiobooks > Audiobook

Network Client — Music Surfin^{a)} > Album^{c)} > Track
— Playlist^{a)} > Playlist > Track
— Web Radio^{a)} > Station > Program
— Music Library^{b)} > Album > Track

^{a)} Displayed only when M-crew Server is connected.

^{b)} Displayed only when a DLNA server other than M-crew Server is connected.

^{c)} Displayed as “Genre”, “Artist” or “Album”, depending on setting of “List Mode”.

To operate the TDM-iP1 or TDM-NC1 using the adapter menu

Make sure that “Adapter GUT” is selected in step 5 in “Selecting an operation screen to operate the component connected to the DIGITAL MEDIA PORT adapter” (page 93). For details on operating the adapter using the adapter GUI menu, refer to the operating instructions supplied with the adapter you are using.

To operate the TDM-iP1 using the iPod menu

Make sure that “iPod” is selected in step 5 in “Selecting an operation screen to operate the component connected to the DIGITAL MEDIA PORT adapter” (page 93).

For details on operating the iPod, refer to the operating instruction supplied with the iPod.

Playing the selected track

During playback of the selected track, the displayed screen changes depending on the DIGITAL MEDIA PORT adapter connected.

TDM-iP1

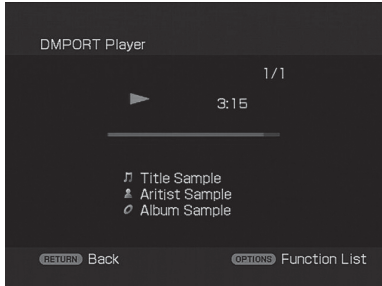

TDM-NC1

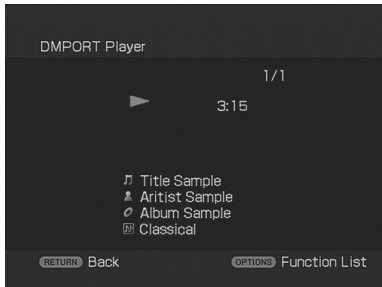

You can also operate the components connected to the DIGITAL MEDIA PORT adapter using the following buttons on the remote of the receiver.

To	Do the following
Play	Press ▶ .
Pause	Press ⏸ . To resume play, press the button again.
Stop	Press ■ .*
Find the beginning of a track during playback, or find the beginning of the previous track	Press ⏮ .
Find the beginning of the next track	Press ⏭ .
Skip to the previous album	Press ⏪ .
Skip to the next album	Press ⏩ .
Go backward/forward	Press ◀/▶ .**

* When a TDM-iP1 is connected, the receiver enters pause mode when **■** is pressed.

** Fast-backward/forward while pressing and holding the **◀/▶** button.

Option parameters in the play modes

■ Repeat Mode (TDM-iP1 only)

- Off
- One
- All

■ Shuffle (TDM-iP1 only)

- Off
- Songs
- Albums

■ List Mode (TDM-NC1 only)

- All Tracks
- Disc List
- Artist List
- Genre List

Tip

The List Mode can be used with the Function List menu even when the list is displayed.

DIGITAL MEDIA PORT message list

Message appears	Explanation
No Adapter	The adapter is not connected.
No Device	There is no device connected to the adapter.
No Audio	No audio file was found.
Loading	The data is being read.
No Server*	There is no server connected.
No Track*	No track was found.
No Item*	No item was found.
Connecting*	Connecting to the server.
Configuring*	The network is setting up.
Warning*	Check the display of the DIGITAL MEDIA PORT adapter.
Party Mode*	The unit is currently in party mode "Guest".
Searching*	Searching the server.

* TDM-NC1 only.

Naming inputs

You can enter a name of up to 8 characters for inputs and display it.

This is convenient for labeling the jacks with the names of the connected components.

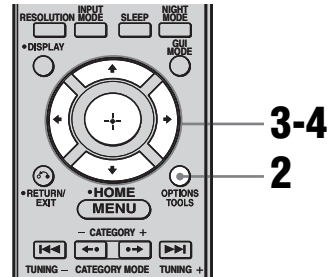

1 Choose the item you want to name.

You can name the following items.

- Auto Calibration position (page 44)
- Inputs (page 50)
- Preset stations (page 75)

2 Press OPTIONS.

3 Select "Name Input", then press .

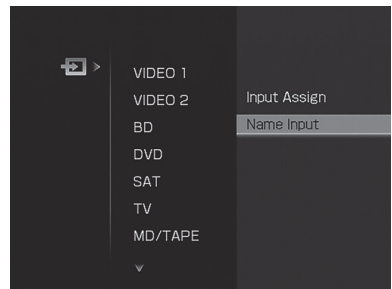

4 Press , , , or to select a character, then press .

The name you entered is registered.

To cancel naming input

Press RETURN/EXIT .

Switching between digital and analog audio (INPUT MODE)

When you connect components to both digital and analog audio input jacks on the receiver, you can fix the audio input mode to either of them, or switch from one to the other, depending on the type of material you intend to watch.

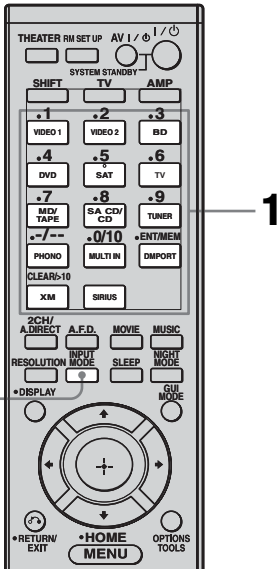

1 Press the input button.

You can also use INPUT SELECTOR on the receiver.

2 Press INPUT MODE repeatedly to select the audio input mode.

The selected audio input mode appears on the display window.

Audio input modes

- **AUTO**
Gives priority to digital audio signals when there are both digital and analog connections. If there are more than one digital connection, HDMI audio signals have priority over COAXIAL and OPTICAL audio signals.
If there are no digital audio signals, analog audio signals are selected.
- **ANALOG**
Specifies the analog audio signals input to the AUDIO IN (L/R) jacks.

Notes

- Some audio input modes may not be set up depending on the input.
- When XM, SIRIUS or DMPORT input is selected, “-----” appears on the display, and you cannot select other modes. Select an input mode other than the XM, SIRIUS and DMPORT input, then set the audio input mode.
- When “Analog Direct” is being used, or the multi channel input is selected, audio input is automatically set to “ANALOG”. You cannot select other modes.

Enjoying the sound/ images from other inputs

You can reassign video and/or audio signals to another input.

Example: Connect the OPTICAL OUT jack of the DVD player to the OPTICAL VIDEO 1 IN jack of this receiver when you want to input the only digital optical audio signals from the DVD player.

Connect the component video jack of the DVD player to the COMPONENT VIDEO COMPO 1 IN jack of this receiver when you want to input the video signals from the DVD player. Assign video and/or audio signals to the DVD input jack using “Input Assign” in the Input menu.

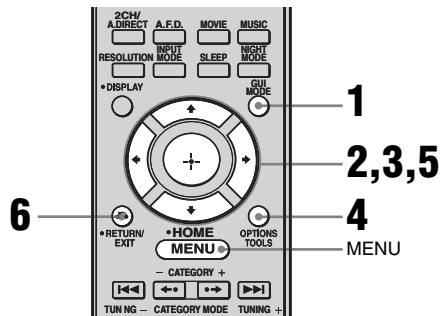

1 Press GUI MODE repeatedly to select “GUI ON”.

“GUI MODE” appears on the display window of the receiver and the GUI menu appears on the TV screen. Press MENU if the GUI menu does not appear on the TV screen.

2 Press \uparrow/\downarrow repeatedly to select “Input”, then press \oplus or \rightarrow .

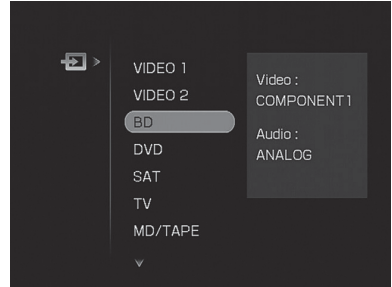

3 Press \uparrow/\downarrow to select the input name you want to assign.

4 Press OPTIONS, then select “Input Assign”.

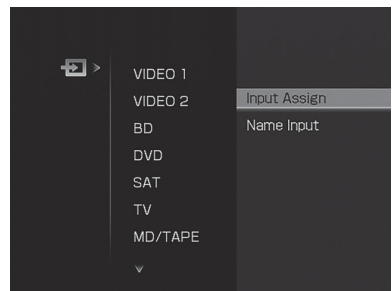

5 Select the audio and/or video signals you want to assign to the input which you selected in step 3 using $\uparrow/\downarrow/\leftarrow/\rightarrow$.

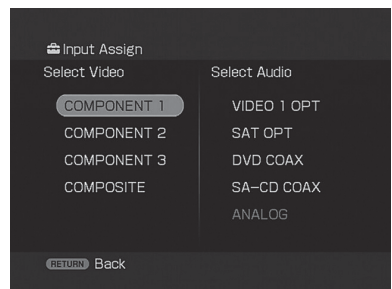

6 Press RETURN/EXIT \rightarrow to enter the setting.

Input name		VIDEO1	VIDEO2	BD	DVD	SAT	MD/ TAPE	SA-CD/ CD	MULTI IN
Assignable video input jacks	COMPONENT 1	○	○	○	○	○	○	○	○
	COMPONENT 2	○	○	○	○	○	○	○	○
	COMPONENT 3	○	○	○	○	○	○	○	○
	COMPOSITE	○	○	○	○	○	–	–	–
	NONE	–	–	–	–	–	○	○	○
Assignable audio input jacks	VIDEO 1 OPT	○	○	○	○	–	○	○	–
	SAT OPT	–	○	○	○	○	○	○	–
	DVD COAX	○	○	○	○	○	○	–	–
	SA-CD COAX	○	○	○	–	○	○	○	–

Notes

- You cannot assign optical signals from an input source to the optical input jacks on the receiver, and you cannot assign coaxial signals from the input source to the coaxial input jacks on the receiver.
- When you assign the digital audio input, the INPUT MODE setting may change automatically.

Changing the display

You can check the sound field, etc., by changing the information on the display.

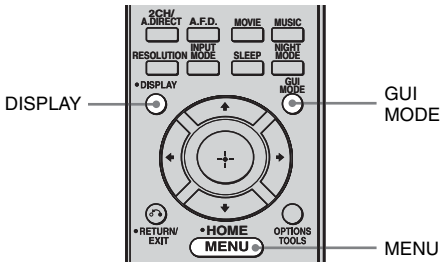

Press DISPLAY repeatedly.

Each time you press DISPLAY, the display will change as follows.

Input you selected* → Original input name → Sound field currently applied → Volume → Stream information

FM and AM band

Preset station name* → Frequency → Sound field currently applied → Volume

* Index name appears only when you have assigned one to the input or preset station. Index name does not appear when only blank spaces have been entered.

Note

Character or marks may not be displayed for some languages.

Tip

You cannot switch the display while “GUI MODE” is shown on the display window. Press GUI MODE repeatedly to select “GUI OFF”.

About the indicators on the display window

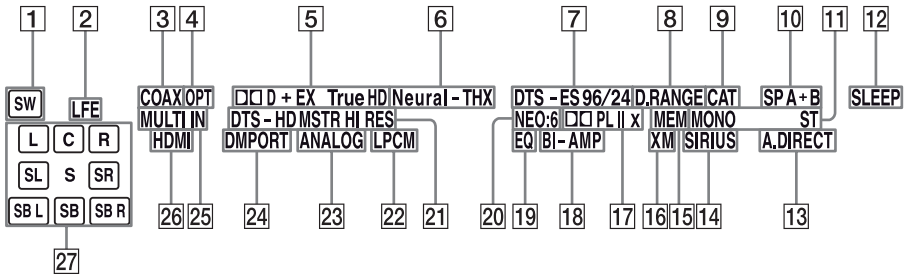

Name	Function
1 SW	Lights up when subwoofer is connected and the audio signal is output from the SUBWOOFER jack. While this indicator lights up, the receiver creates a subwoofer signal based on the LFE signal in the disc being played back or the low frequency components of the front channels.
2 LFE	Lights up when the disc being played back contains an LFE (Low Frequency Effects) channel and the LFE channel signal is actually being reproduced. Since the LFE signal is not recorded in all parts of the input signal the bar indication will fluctuate (and may turn off) during playback.
3 COAX	Lights up when INPUT MODE is set to "AUTO" and the source signal is a digital signal being input through the COAXIAL jack.

Name	Function
4 OPT	Lights up when INPUT MODE is set to "AUTO" and the source signal is a digital signal being input through the OPTICAL jack.
5 <input type="checkbox"/> D/ <input type="checkbox"/> D EX/ <input type="checkbox"/> D+/ <input type="checkbox"/> TrueHD	<p>"<input type="checkbox"/> D" lights up when the receiver is decoding Dolby Digital signals.</p> <p>"<input type="checkbox"/> D EX" lights up when the receiver is decoding Dolby Digital Surround EX signals.</p> <p>"<input type="checkbox"/> D+" lights up when the receiver is decoding Dolby Digital Plus signals.</p> <p>"<input type="checkbox"/> TrueHD" lights up when the receiver is decoding Dolby TrueHD signals.</p> <p>Note When playing a Dolby Digital format disc, be sure that you have made digital connections and that INPUT MODE is set to "AUTO" (page 97).</p>
6 Neural-THX	Lights up when the receiver applies Neural-THX processing to input signals.

Name	Function
7 DTS/ DTS-ES/ DTS 96/24	<p>“DTS” lights up when the receiver is decoding DTS signals.</p> <p>“DTS-ES” lights up when the receiver is decoding DTS-ES signals.</p> <p>“DTS 96/24” lights up when the receiver is decoding DTS 96/24 (DTS 96 kHz/24 bit) signals.</p> <p>Note When playing a DTS format disc, be sure that you have made digital connections and that INPUT MODE is set to “AUTO” (page 97).</p>
8 D.RANGE	Lights up when dynamic range compression is activated.
9 CAT	Lights up when category mode is selected during the satellite radio operation.
10 SP A/SP B/ SP A+B	Lights up according to the speaker system used (page 44). However, these indicators do not light up if the speaker output is turned off or if headphones are connected.
11 Tuner indicators	Lights up when using the receiver to tune in radio stations, etc.
12 SLEEP	Lights up when the sleep timer is activated.
13 A.DIRECT	Lights up when the receiver is processing Analog Direct signals.
14 SIRIUS	Lights up when the SiriusConnect Home tuner is connected and “SIRIUS” is selected.
15 MEM	Lights up when a memory function, such as Preset Memory etc., is activated.

Name	Function
16 XM	Lights up when XM Mini-Tuner and Home Dock are connected and “XM” is selected.
17 <input type="checkbox"/> PL/ <input type="checkbox"/> PL II/ <input type="checkbox"/> PL Iix	<p>“<input type="checkbox"/> PL” lights up when the receiver applies Pro Logic processing to 2 channel signals in order to output the center and surround channel signals.</p> <p>“<input type="checkbox"/> PL II” lights up when the Pro Logic II decoder is activated.</p> <p>“<input type="checkbox"/> PL Iix” lights up when the Pro Logic Iix decoder is activated.</p> <p>However, these indicators do not light up if both the center and surround speakers are not connected and you select a sound field using the A.F.D. button.</p> <p>Note Dolby Pro Logic Iix decoding does not function for signals with a sampling frequency of more than 48 kHz.</p>
18 BI-AMP	Lights up when BI-AMP Speaker setting is set to “ON”.
19 EQ	Lights up when the equalizer is activated.
20 NEO:6	Lights up when DTS Neo:6 Cinema/Music decoding is activated.
21 DTS-HD MSTR/ DTS-HD HI RES	<p>“DTS-HD MSTR” lights up when the receiver is decoding DTS-HD Master Audio signals.</p> <p>“DTS-HD HI RES” lights up when the receiver is decoding DTS-HD High Resolution signals.</p>
22 LPCM	Lights up when Linear PCM signals are detected.

Name	Function
23 ANALOG	Lights up when – INPUT MODE is set to “AUTO” and no digital signal is being input through the COAXIAL, OPTICAL or HDMI jacks. – INPUT MODE is set to “ANALOG”. – the “Analog Direct” is being used.
24 DMPORT	Lights up when DIGITAL MEDIA PORT adapter is connected and “DMPORT” is selected.
25 MULTI IN	Lights up when multi channel input is selected.
26 HDMI	Lights up when the receiver recognizes a component connected via an HDMI IN jack.

Name	Function
27 Playback channel indicators	The letters (L, C, R, etc.) indicate the channels being played back. The boxes around the letters vary to show how the receiver downmixes the source sound (based on the speaker settings).
L	Front Left
R	Front Right
C	Center (monaural)
SL	Surround Left
SR	Surround Right
S	Surround (monaural or the surround components obtained by Pro Logic processing)
SBL	Surround Back Left
SBR	Surround Back Right
SB	Surround Back (the surround back components obtained by 6.1 channel decoding)
	Example: Recording format (Front/Surround): 3/2.1 When Speaker Pattern is set to “3/0.1” (page 109) Sound Field: A.F.D. AUTO

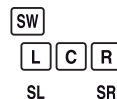

Using the sleep timer

You can set the receiver to turn off automatically at a specified time.

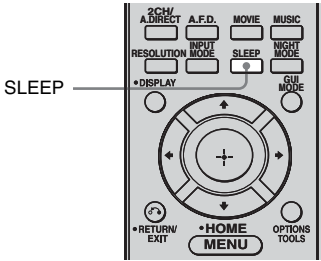

Press SLEEP repeatedly while the power is on.

Each time you press SLEEP, the display changes cyclically as follows:

0:30:00 → 1:00:00 → 1:30:00 → 2:00:00
→ OFF

When sleep timer is being used, “SLEEP” lights up in the display.

Tip

To check the remaining time before the receiver turns off, press SLEEP. The remaining time appears on the display. If you press SLEEP again, the sleep timer will be cancelled.

Recording using the receiver

You can record from a video/audio component using the receiver. Refer to the operating instructions supplied with your recording component.

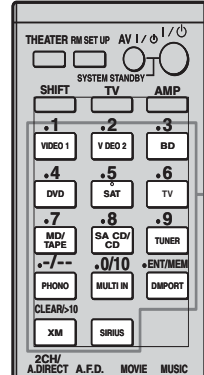

Recording onto a MiniDisc or audio tape

You can record onto a MiniDisc or audio tape using the receiver. See the operating instructions supplied with your MD deck or tape deck.

1 Press the input button of the playback component.

You can also use INPUT SELECTOR on the receiver.

2 Prepare the playback component for playing.

For example, insert a CD into the CD player.

3 Prepare the recording component.

Insert a blank MD or tape into the recording deck and adjust the recording level.

4 Start recording on the recording deck, then start playback on the playback component.

Notes

- Sound adjustments do not affect the signal output from the MD/TAPE OUT jacks.
- The audio input signals from the MULTI CHANNEL INPUT jacks are not output.

Recording onto a recording media

1 Press the input button of the playback component.

You can also use INPUT SELECTOR on the receiver.

2 Prepare the component for playing.

For example, insert the video tape you want to copy into the VCR.

3 Prepare the recording component.

Insert a blank video tape, etc., into the recording component (connected to the VIDEO 1 OUT jack) for recording.

4 Start recording on the recording component, then start playback on the playback component.

Notes

- Some sources contain copy guards to prevent recording. In this case, you may not be able to record from the sources.
- The audio input signals from the MULTI CHANNEL INPUT jacks are not output.
- Only analog input signals are output from the analog output jack (for recording).
- HDMI sound cannot be recorded.

Using a bi-amplifier connection

If you are not using surround back speakers, you can use the SURROUND BACK SPEAKERS terminals for the front speakers for use with a bi-amplifier connection.

To connect speakers

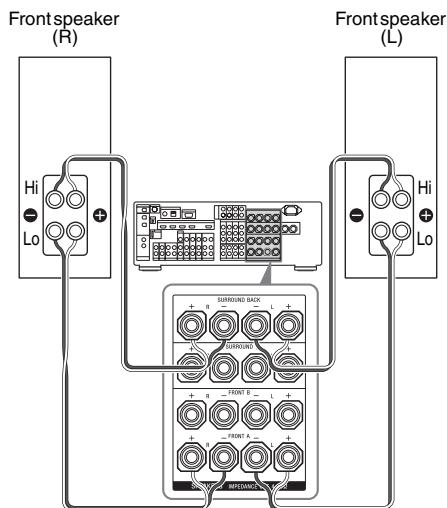

Connect the terminals on the Lo (or Hi) side of the front speakers to the FRONT SPEAKERS A terminals, and connect the terminals on the Hi (or Lo) side of the front speakers to the SURROUND BACK SPEAKERS terminals. Make sure that metal fittings of Hi/Lo attached to the speakers have been removed from the speakers. Not doing so may cause the receiver to malfunction.

To set up speakers

Set “Bi-AMP Speaker” to “ON” in the Speaker settings menu. The same signals output from the FRONT SPEAKERS A jacks can be output from the SURROUND BACK SPEAKERS terminals by setting “Bi-AMP Speaker” to “ON”.

Notes

- You cannot use the FRONT SPEAKERS B jacks for a bi-amplifier connection.
- When you use the Auto Calibration function, make the bi-amplifier settings before you perform Auto Calibration.
- If you make the bi-amplifier settings, the speaker level, and equalizer settings of the surround back speakers become invalid, and those of the front speakers are used.
- Signals output from the PRE OUT jacks are used with the same settings as those of the SPEAKERS terminals.

Operating without connecting to the TV

You can operate this receiver using the display even if you do not use a GUI when a TV monitor is not connected.

Press GUI MODE repeatedly to select “GUI OFF”.

When “GUI MODE” is displayed in the display window, the menu is set to display on the TV screen using a GUI.

Navigating through menus on the display

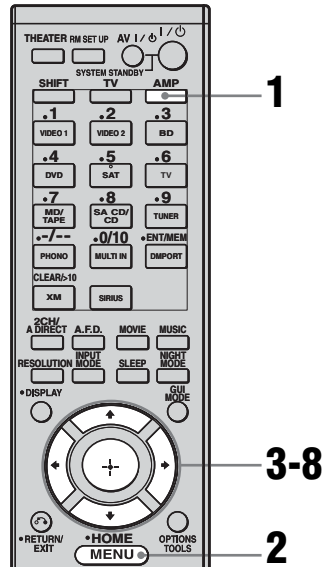

- 1** Press AMP.
- 2** Press MENU.
- 3** Press \uparrow/\downarrow repeatedly to select the menu you want.

- 4** Press \oplus or \rightarrow to enter the menu.
- 5** Press \uparrow/\downarrow repeatedly to select the parameter you want to adjust.
- 6** Press \oplus or \rightarrow to enter the parameter.
- 7** Press \uparrow/\downarrow repeatedly to select the setting you want.
- 8** Press \oplus to enter the setting.

To return to the previous display

Press \leftarrow .

To exit the menu

Press MENU.

Note

Some parameters and settings may appear dimmed on the display. This means that they are either unavailable or fixed and unchangeable.

Overview of the menus

The following options are available in each menu. For details on navigating through menus, see page 106.

Menu [Display window]	Parameters [Display window]	Settings	Initial setting
Auto Calibration settings [<AUTO CAL>]	Auto Calibration start [A.CAL START]		
	Calibration type [CAL TYPE]	FULL, FLAT, ENGINEER, FRONT REF, OFF	FULL FLAT
	Position [POSITION]	POS 1, POS 2, POS 3	POS 1
	Naming inputs [NAME IN]		
Level settings [<LEVEL>]	Test tone [TEST TONE]	OFF, AUTO ■■■■ ^{a)} , FIX ■■■■ ^{a)}	OFF
	Phase noise [P. NOISE]	OFF, FL/FR, FL/CNT, CNT/FR, FR/SL, FR/SR, SR/SL, SR/SBR, SBR/SBL, SR/SB, SBL/SL, SB/SL, SL/FL, FL/SR	OFF
	Phase audio [P. AUDIO]	OFF, FL/FR, FL/CNT, CNT/FR, FR/SL, FR/SR, SR/SL, SR/SBR, SBR/SBL, SR/SB, SBL/SL, SB/SL, SL/FL, FL/SR	OFF
	Front left speaker level [FL LEVEL]	FL -10.0 dB to FL +10.0 dB (0.5 dB step)	FL 0 dB
	Front right speaker level [FR LEVEL]	FR -10.0 dB to FR +10.0 dB (0.5 dB step)	FR 0 dB
	Center speaker level [CNT LEVEL]	CNT -20.0 dB to CNT +10.0 dB (0.5 dB step)	CNT 0 dB
	Surround left speaker level [SL LEVEL]	SL -20.0 dB to SL +10.0 dB (0.5 dB step)	SL 0 dB
	Surround right speaker level [SR LEVEL]	SR -20.0 dB to SR +10.0 dB (0.5 dB step)	SR 0 dB
	Surround back speaker level [SB LEVEL]	SB -20.0 dB to SB +10.0 dB (0.5 dB step)	SB 0 dB
	Surround back left speaker level [SBL LEVEL]	SBL -20.0 dB to SBL +10.0 dB (0.5 dB step)	SBL 0 dB
	Surround back right speaker level [SBR LEVEL]	SBR -20.0 dB to SBR +10.0 dB (0.5 dB step)	SBR 0 dB
	Subwoofer level [SW LEVEL]	SW -20.0 dB to SW +10.0 dB (0.5 dB step)	SW 0 dB
	Dynamic range compressor [D. RANGE]	COMP. MAX, COMP. STD, COMP. AUTO, COMP. OFF	COMP. AUTO

Menu [Display window]	Parameters [Display window]	Settings	Initial setting
Speaker settings [<SPEAKER>]	Speaker pattern [SP PATTERN]	3/4.1, 3/4, 3/3.1, 3/3, 2/4.1, 2/4, 3/2.1, 3/2, 2/3.1, 2/3, 2/2.1, 2/2, 3/0.1, 3/0, 2/0.1, 2/0	3/4.1
	Front speakers [FRT SP]	LARGE, SMALL	LARGE
	Center speaker [CNT SP]	LARGE, SMALL	LARGE
	Surround speakers [SUR SP]	LARGE, SMALL	LARGE
	Bi-amplifier [BI-AMP SP]	OFF, ON	OFF
	Front left speaker distance [FL DIST.]	FL 3'3" to FL 32'9" (FL 1.0 m to FL 10.0 m) (1 inch (0.01 m) step)	FL 9'10" (3 m)
	Front right speaker distance [FR DIST.]	FR 3'3" to FR 32'9" (FR 1.0 m to FR 10.0 m) (1 inch (0.01 m) step)	FR 9'10" (3 m)
	Center speaker distance [CNT DIST.]	CNT 3'3" to CNT 32'9" (CNT 1.0 m to CNT 10.0 m) (1 inch (0.01 m) step)	CNT 9'10" (3 m)
	Surround left speaker distance [SL DIST.]	SL 3'3" to SL 32'9" (SL 1.0 m to SL 10.0 m) (1 inch (0.01 m) step)	SL 9'10" (3 m)
	Surround right speaker distance [SR DIST.]	SR 3'3" to SR 32'9" (SR 1.0 m to SR 10.0 m) (1 inch (0.01 m) step)	SR 9'10" (3 m)
	Surround back speaker distance [SB DIST.]	SB 3'3" to SB 32'9" (SB 1.0 m to SB 10.0 m) (1 inch (0.01 m) step)	SB 9'10" (3 m)
	Surround back left speaker distance [SBL DIST.]	SBL 3'3" to SBL 32'9" (SBL 1.0 m to SBL 10.0 m) (1 inch (0.01 m) step)	SBL 9'10" (3 m)
	Surround back right speaker distance [SBR DIST.]	SBR 3'3" to SBR 32'9" (SBR 1.0 m to SBR 10.0 m) (1 inch (0.01 m) step)	SBR 9'10" (3 m)
	Subwoofer distance [SW DIST.]	SW 3'3" to SW 32'9" (SW 1.0 m to SW 10.0 m) (1 inch (0.01 m) step)	SW 9'10" (3 m)
	Distance unit ^{b)} [DIST. UNIT]	METER, FEET	FEET
	Front speakers crossover frequency ^{b)} [FRT CROSS]	CROSS 40 Hz to CROSS 200 Hz (10 Hz step)	CROSS 120 Hz
	Center speaker crossover frequency ^{b)} [CTR CROSS]	CROSS 40 Hz to CROSS 200 Hz (10 Hz step)	CROSS 120 Hz
	Surround speakers crossover frequency ^{b)} [SUR CROSS]	CROSS 40 Hz to CROSS 200 Hz (10 Hz step)	CROSS 120 Hz
	Speaker Impedance [SP IMP.]	8 ohms, 4 ohms	8 ohms

Menu [Display window]	Parameters [Display window]	Settings	Initial setting
Surround settings [<SURROUND>]	Sound field selection [S.F. SELECT]		
	Enhanced surround mode [E.SUR MODE]	PLIIX ^(c) , PLIIX ^(c) , NEO6 CIN, NEO6 MUS, NEURAL-THX	PLIIX
	Effect level [EFFECT]	EFCT. 50%, EFCT. 80%, EFCT. 100%, EFCT. 150%	EFCT. 100%
EQ settings [<EQ>]	Front speakers bass level [FRT BASS]	FRT B. -10 dB to FRT B. +10 dB (1 dB step)	FRT B. 0 dB
	Front speakers treble level [FRT TREBLE]	FRT T. -10 dB to FRT T. +10 dB (1 dB step)	FRT T. 0 dB
	Center speaker bass level [CNT BASS]	CNT B. -10 dB to CNT B. +10 dB (1 dB step)	CNT B. 0 dB
	Center speaker treble level [CNT TREBLE]	CNT T. -10 dB to CNT T. +10 dB (1 dB step)	CNT T. 0 dB
	Surround speakers bass level [SUR BASS]	SUR B. -10 dB to SUR B. +10 dB (1 dB step)	SUR B. 0 dB
	Surround speakers treble level [SUR TREBLE]	SUR T. -10 dB to SUR T. +10 dB (1 dB step)	SUR T. 0 dB
Tuner settings [<TUNER>]	FM station receiving mode [FM MODE]	STEREO, MONO	STEREO
	Naming preset stations [NAME IN]		
	XM antenna aiming mode [XM ANT AIM] ^(d)		
	XM radio ID [XM ID]		
	Parental lock [PARENTAL]	OFF, ON	OFF
	Lock code edit [CODE EDIT]		
	Sirius antenna aiming mode [SR ANT AIM] ^(e)		
	Sirius radio ID [SIRIUS ID]		

Menu [Display window]	Parameters [Display window]	Settings	Initial setting
Audio settings [<AUDIO>]	Synchronizes audio with video output [A/V SYNC]	0 ms to 300 ms (10 ms step)	0 ms
	Digital broadcast language selection [DUAL MONO]	MAIN/SUB, MAIN, SUB	MAIN
	Digital audio input decoding priority [DEC. PRIO]	DEC. AUTO, DEC. PCM	DEC. AUTO
	Digital audio input assignment [A. ASSIGN]		
	VIDEO 1? ➔	VIDEO 1 OPT, SAT OPT, DVD COAX, SA-CD COAX, ANALOG	
	VIDEO 2? ➔		
	BD? ➔		
	DVD? ➔		
	SAT? ➔		
	MD/TAPE? ➔		
SA-CD/CD? ➔			
Video settings [<VIDEO>]	Converting video signals [RESOLUTION]	DIRECT, AUTO, 480/576i, 480/576p, 720p, 1080i, 1080p	AUTO
	Video input assignment [V. ASSIGN]		
	VIDEO 1? ➔	COMPONENT 1, COMPONENT 2, COMPONENT 3, COMPOSITE	
	VIDEO 2? ➔		
	BD? ➔		
	DVD? ➔		
	SAT? ➔		
	MD/TAPE? ➔	COMPONENT 1, COMPONENT 2, COMPONENT 3, NONE	
	SA-CD/CD? ➔		
	MULTI IN? ➔		
HDMI settings [<HDMI>]	Control for HDMI [CTRL:HDMI]	CTRL OFF, CTRL ON	CTRL OFF
	Setting HDMI audio input [AUDIO OUT]	AMP, TV+AMP	AMP
	Subwoofer level for HDMI [SW LEVEL]	SW AUTO, SW +10 dB, SW 0 dB	SW 0 dB

Menu [Display window]	Parameters [Display window]	Settings	Initial setting
System settings [<SYSTEM>]	Naming inputs [NAME IN]		
	Brightness of the display [DIMMER]	0% DOWN, 60% DOWN, 100% DOWN	0% DOWN
	RS-232C Control [RS-232C]	OFF, ON	ON

- a) ■■■ represent a speaker channel (FL, FR, CNT, SL, SR, SB, SBL, SBR, SW).
- b) You cannot select this setting if your speaker is set to "LARGE".
- c) This parameter is available depending on the speaker configuration.
- d) This parameter is only available if the XM Mini-Tuner and Home Dock is connected to the XM jack on the receiver.
- e) This parameter is only available if the SiriusConnect Home Tuner is connected to the SIRIUS jack on the receiver.

Performing Auto Calibration

For details on the Auto Calibration, see “9: Calibrating the appropriate speaker settings automatically (Auto Calibration)” (page 44). Refer to “Before you perform the Auto Calibration” (page 44) before performing the Auto Calibration.

To operate on the receiver

- 1 Press GUI MODE repeatedly to select “GUI OFF”.
- 2 Press AMP.
Receiver operation is enabled.
- 3 Press MENU.
- 4 Press \uparrow/\downarrow repeatedly to select “<AUTO CAL>”, then press \oplus .
- 5 Press \uparrow/\downarrow repeatedly to select “A.CAL START”, then press \oplus to start the measurement.
Measurement starts in 5 seconds. A count down is displayed.

Note

While the time is counting down, stand away from the measurement area to avoid measurement error.

- 6 Measurement starts.
The measurement process will take approximately 30 seconds. Wait until the measurement process completes.

To cancel Auto Calibration

The measurement will be canceled when you do the following:

- Press I/⏻, input buttons or MUTING.
- Press SPEAKERS (OFF/A/B/A+B) on the receiver.
- Change the volume level.
- Connect the headphones.

Tips

- Operations other than turning the receiver on or off are deactivated during Auto Calibration.
- The measurements may not be performed correctly or Auto Calibration cannot be performed when special speakers, such as dipole speakers are used.

To confirm/save Auto Calibration when GUI function is turned off

- 1 Confirm the measurement result.
When the measurement ends, a beep sounds and the measurement result appears on the display window.

Measurement result	Display window	Explanation
When the measurement process completes properly	COMPLETE	Proceed to step 2.
When the measurement process fails	E- ■■■■■■■	See “Message list after Auto Calibration measurement” (page 49).

- 2 Press \uparrow/\downarrow repeatedly to select the item, then press \oplus .

Item	Explanation
RETRY	Performs the Auto Calibration again.
SAVE EXIT	Saves the measurement results and exits the setting process.
WARN CHECK	Displays a warning concerning the measurement results. See “Message list after Auto Calibration measurement” (page 49).
PHASE INFO.	Displays the phase of each speaker (in phase/out of phase). See “When you select “PHASE INFO.””.
DIST. INFO.	Displays the measurement result for speaker distance.
LEVEL INFO.	Displays the measurement result for speaker level.

Item	Explanation
EXIT	Exits the setting process without saving the measurement results.

3 Select “SAVE EXIT” in step 2.
The measurement results are saved.

4 Press \uparrow/\downarrow repeatedly to select the Auto Calibration Type, then press \oplus .

Auto Calibration Type	Explanation
FULL FLAT	Makes the measurement of frequency from each speaker flat.
ENGINEER	Sets the frequency characteristics to a set that matches that of the Sony listening room standard.
FRONT REF	Adjusts the characteristics of all the speakers to match the characteristics of the front speaker.
OFF	Set the Auto Calibration EQ to off.

Tip

The size of a speaker (LARGE/SMALL) is determined by the low frequency characteristics. The measurement results may vary, depending on the position of the optimizer microphone and speakers, and the shape of the room. It is recommended that you follow the measurement results. However, you can change those settings in the Speaker settings menu. Save the measurement results first, then try to change the settings if you want.

When you select “PHASE INFO.”

You can check the phase of each speaker (in phase/out of phase).

Press \uparrow/\downarrow repeatedly to select a speaker, then press \oplus to return to step 1 in “To confirm/save Auto Calibration when GUI function is turned off”.

Display window	Explanation
■■■■*:IN	The speaker is in phase.
■■■■*:OUT	The speaker is out of phase. The “+” and “-” terminals of the speaker may be connected the other way around. However, depending on the speakers, “■■■■*:OUT” appears on the display even though the speakers are connected properly. This is because of the speakers’ specifications. In this case, you can continue to use the receiver.
■■■■*-- --	No speakers are connected.

* ■■■■ represent a speaker channel.

FL	Front Left
FR	Front Right
CNT	Center
SL	Surround Left
SR	Surround Right
SB	Surround Back
SBL	Surround Back Left
SBR	Surround Back Right
SW	Subwoofer

Tip

Depending on the position of the subwoofer, the measurement results for polarity may vary. However, there will be no problems even if you continue to use the receiver with that value.

Selecting a sound field type

For details on each sound field type, see “Enjoying a pre-programmed sound field” (page 59).

Press 2CH/A.DIRECT, A.F.D., MOVIE, or MUSIC repeatedly.

The selected sound field type appears on the display.

To select Enhanced Surround Mode

- 1 Press AMP.
- 2 Press MENU.
- 3 Press \uparrow/\downarrow repeatedly to select “<SURROUND>”, then press \oplus or \rightarrow .
- 4 Press \uparrow/\downarrow repeatedly to select “<E.SUR MODE>”, then press \oplus or \rightarrow .
- 5 Press \uparrow/\downarrow repeatedly to select the Enhanced Surround Mode you want, then press \oplus .

Note

The selected Enhanced Surround Mode can only be applied if you have selected “E.SURROUND” by pressing A.F.D repeatedly.

Listening to the sound without any adjustment (ANALOG DIRECT)

Press 2CH/A.DIRECT repeatedly to select “A.DIRECT”.

Listening to the FM/AM radio

For details on the tuner function, see “Tuner Operations” (page 73).

Tuning radio stations

- 1 Press TUNER repeatedly to select the FM or AM band.
You can also use INPUT SELECTOR on the receiver.
- 2 Press TUNING + or TUNING –.
Press TUNING + to scan from low to high frequencies, press TUNING – to scan from high to low frequencies. The receiver stops scanning whenever a station is received.
You can also press TUNING MODE on the receiver to select “AUTO” and then turn TUNING +/- to select stations.

Selecting a frequency directly (Direct Tuning)

- 1 After selecting the FM or AM band, press D.TUNING.
- 2 Press SHIFT, then press numeric buttons to enter the frequency.
- 3 Press \oplus .

Presetting radio stations

1 Tune in the station that you want to preset.

For details on the operation, refer to “Tuning radio stations”.

2 Press SHIFT, then press ENT/MEM.

You can also use MEMORY/ENTER on the receiver.

“MEM” lights up for a few seconds.

Perform steps 3 and 4 before “MEM” disappears.

3 Press PRESET + or PRESET – to select a preset number.

30 FM and 30 AM preset numbers are available. If “MEM” disappears before you select the preset number, start again from step 2.

4 Press ENT/MEM.

If SHIFT indicator is light off before you press ENT/MEM, press SHIFT.

You can also use MEMORY/ENTER on the receiver. The station is stored as the selected preset number.

If “MEM” disappears before you press ENT/MEM, start again from step 2.

5 Repeat steps 1 to 4 to preset another station.

Selecting a preset station

- 1 Press TUNER repeatedly to select the FM or AM band.
- 2 Press PRESET+ or PRESET – repeatedly to select the preset station you want.

You can also press SHIFT, then press numeric buttons to select the preset station you want. Then, press \oplus to enter the selection.

You can also press TUNING MODE on the receiver repeatedly to select “PRESET” then use TUNING +/- to select the preset station you want.

Listening to satellite tuner

For details on XM/SIRIUS Radio service, refer to “Listening to satellite radio” (page 76) in “Tuner Operations”.

Aiming the XM Radio or SIRIUS Antenna

You can use “XM ANT AIM” or “SR ANT AIM” in the Tuner settings menu to help you aim the antenna for optimal signal reception.

- 1 Press XM to select “XM RADIO” or press SIRIUS to select “SIRIUS”.
You can also use INPUT SELECTOR on the receiver.
- 2 Press AMP.
- 3 Press MENU.
- 4 Press \uparrow/\downarrow repeatedly to select “<TUNER>”.
- 5 Press \oplus or \rightarrow to enter the menu.
- 6 Press \uparrow/\downarrow repeatedly to select “XM ANT AIM” or “SR ANT AIM”.
- 7 Press \oplus or \rightarrow to enter the parameter.

- 8 While checking the parameter, aim your antenna to where the best reception will be received.

For details on the parameter, see “XM Signal Strength” or “SIRIUS Signal Strength” below.

XM Signal Strength

Signal strength	Signal type	
	Satellite	Terrestrial
GOOD	S:3	T:3
MARGINAL	S:2	T:2
WEAK	S:1	T:1
NO SIGNAL	S:0	T:0

SIRIUS Signal Strength

Signal Strength	Signal type	
	Satellite	Terrestrial
EXC (excellent)	S:3	T:3
GOOD	S:2	T:2
WEAK	S:1	T:1
NONE	S:0	T:0

Checking the Satellite Tuner ID

- 1 Press XM to select “XM RADIO” or press SIRIUS to select “SIRIUS”.
You can also use INPUT SELECTOR on the receiver.
- 2 Press TUNING + or TUNING – to select channel 0.
You can also press TUNING MODE on the receiver to select “AUTO” then turn TUNING +/- to select channel 0.
- 3 Check the XM ID or SIRIUS ID on the display and write it in the space provided here.
XM ID: _____
SIRIUS ID: _____

Selecting channels from a category (CATEGORY TUNING)

- 1 Press XM to select “XM RADIO” or press SIRIUS to select “SIRIUS”.
You can also use INPUT SELECTOR on the receiver.
- 2 Press CATEGORY MODE repeatedly to select “ONE CAT”.
 - ALL CAT: You can select a channel from all the categories. The initial setting is “ALL CAT”.
 - ONE CAT: You can select a channel from one category. “CAT” lights up on the display when you set to “ONE CAT” mode.
- 3 Press CATEGORY + or CATEGORY – to select the category you want.
The category is selected and the channel with the lowest number in the specified category is selected.
- 4 Press TUNING + or TUNING – to select the channel.
You can also press TUNING MODE on the receiver to select “AUTO”, then turn TUNING +/- to select the channel.

Selecting a channel number directly (Direct tuning)

- 1 After selecting satellite tuner, press D.TUNING.
- 2 Press SHIFT, then press numeric buttons to enter the channel number.
- 3 Press ⊕.

Displaying the satellite tuner information

Press DISPLAY repeatedly.

Each time you press DISPLAY while tuning in the channel, the display changes cyclically as follows:

Channel name → Channel number →
Category name → Artist name/Feature →
Song/Program title → Composer name
(SIRIUS only) → Signal strength → Sound
field currently applied → Volume

Presetting satellite tuner channels

1 Select a channel you want to preset.

For details on this operation, refer to “Selecting channels from a category (CATEGORY TUNING)”.

2 Press **SHIFT**, then press **ENT/MEM**.

You can also use **MEMORY/ENTER** on the receiver.

“MEM” lights up on the display.

3 Press **PRESET +** or **PRESET –** to select a preset number.

You can also select the number by pressing **SHIFT**, then numeric buttons.

Preset numbers from 1 to 30 are available.

Channel 1 is preset for the preset numbers when you purchase the receiver.

4 Press **ENT/MEM**.

If **SHIFT** indicator is light off before you press **ENT/MEM**, press **SHIFT**.

You can also use **MEMORY/ENTER** on the receiver.

“MEM” lights off.

5 Repeat steps 1 to 4 to preset another channel.

Selecting a preset channel

1 Press **XM** to select “**XM RADIO**” or press **SIRIUS** to select “**SIRIUS**”.

2 Press **PRESET+** or **PRESET –** repeatedly to select the preset channel you want.

You can also press **SHIFT**, then numeric buttons to select the preset channel you want. Then, press **ENT/MEM** to enter the selection.

You can also press **TUNING MODE** on the receiver repeatedly to select “**PRESET**” then use **TUNING +/-** to select the preset channel you want.

Using the Remote

Operating each component using the remote

When you program the remote to control the following Sony or non-Sony components, you can use the buttons on the remote that are marked with circles. Note, however, that some buttons may not operate your component. If you want to change the contents of the input list to match your particular components, see “Programming the remote” (page 120).

Table of buttons used to control each component

Component	TV	VCR	DVD player, DVD/VHS combo	Blu-ray disc player	PSX	Video CD player, LD player	Digital CATV terminal (UC)	DSS (UC)	Digital satellite/terrestrial receiver (EURO)	Tape deck A/B	DAT deck	CD player, MD deck	DIGITAL MEDIA PORT device
Button													
AV I/Ⓞ	●	●	●	●	●	●	●	●	●		●	●	
Numeric buttons (SHIFT mode)	●	●	●	●	●	●	●	●	●	●	●	●	●
TV INPUT, WIDE (SHIFT mode)	●												
-/., >10, CLEAR (SHIFT mode)	●	●	●	●	●	●	●	●		●		●	
ENT/MEM (SHIFT mode)	●	●	●	●	●	● ^{b)}	●	●		●	●	●	
DISPLAY	●	●	●	●	●	●	●	●					●
RETURN/EXIT ⏪	●		●	●	●	●	●	●	●				●
OPTIONS/TOOLS	●		●	●			●	●					
⏪/⏩/⏮/⏭, ⊕, MENU, HOME	●	●	●	●	●		●	●	●				●
⏮/⏪/⏩/⏭	●	●	●	●	●	●	●			● ^{d)}	●	●	●
⏮/⏩	●		●	●	●		●						●
⏮/TUNING -, ⏭/TUNING +	●	●	●	●	●	●	●			●	●	●	●
DISC SKIP			● ^{a)}			● ^{c)}						●	
▶, , ■	●	●	●	●	●	●	●			●	●	●	●
MUTING, MASTER VOL +/-, TV VOL +/-	●												
PRESET +/-, TV CH +/-	●	●	●	●		● ^{b)}	●	●	●				
BD/DVD TOP MENU, BD/DVD MENU			●	●	●								
F1, F2			●	●									

a)DVD player only.

b)LD player only.

c)Video CD only.

d)Tape deck B only.

Programming the remote

You can customize the remote to match the components connected to your receiver. You can even program the remote to control non-Sony components and also Sony components that the remote is normally unable to control. The procedure below uses as an example a case in which a VCR made by a company other than Sony is connected to the VIDEO 1 IN jacks on the receiver.

Before you begin, note that:

- You cannot change the settings of PHONO.
- The remote can control only components that accept infrared wireless control signals.

Be sure to turn on the receiver and point the remote towards the receiver when performing the following procedure.

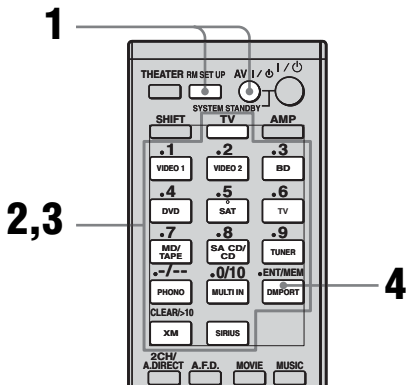

1 Press AV I/O while pressing RM SET UP.

The RM SET UP indicator slowly flashes.

2 Press the input button (including TV) for the component you want to control.

For example, if you are going to control a CD player, press SA-CD/CD.

The RM SET UP and the SHIFT button indicator light up.

If you press the button for a component of which you cannot program the remote, such as DMPORT, XM or SIRIUS, etc., the RM SET UP indicator keeps flashing.

3 Press the numeric buttons to enter the numeric code (or one of the codes if more than one code exists) corresponding to the component and the maker of the component you want to control.

See the tables on page 121–124 for information on the numeric code(s).

Note

For a TV remote code value, only numbers in the 500's are valid.

4 Press ENT/MEM.

Once the numeric code has been verified, the RM SET UP indicator slowly flashes twice and the remote automatically exits the programming mode.

5 Repeat steps 1 to 4 to control other components.

Notes

- The indicator turns off while a valid button is pressed.
- In step 2, if you press TUNER, you can only program the button to control a tuner (page 124).
- In step 2, if you want to change to other input, press SHIFT and then press the new input buttons you want.
- For the numeric codes, only the last three numbers entered are valid.

To cancel programming

Press RM SET UP during any step. The RM SET UP indicator flashes 5 times in quick succession. The remote automatically exits the programming mode.

To activate the input after programming

Press the programmed button to activate the input you want.

If programming is unsuccessful, check the following:

- If the indicator does not light up in step 1, the batteries are weak. Replace both batteries.
- If the indicator flashes 5 times in quick succession while entering the numeric code, an error has occurred. Start again from step 1.

The numeric codes corresponding to the component and the maker of the component

Use the numeric codes in the tables below to control non-Sony components and also Sony components that the remote is normally unable to control. Since the remote signal that a component accepts differs depending on the model and year of the component, more than one numeric code may be assigned to a component. If you fail to program your remote using one of the codes, try using other codes.

Notes

- The numeric codes are based on the latest information available for each brand. There is a chance, however, that your component will not respond to some or all of the codes.
- All of the input buttons on this remote may not be available when used with your particular component.

To control a CD player

Maker	Code(s)
SONY	101, 102, 103
DENON	104, 123
JVC	105, 106, 107
KENWOOD	108, 109, 110
MAGNAVOX	111, 116
MARANTZ	116
ONKYO	112, 113, 114
PANASONIC	115
PHILIPS	116
PIONEER	117
TECHNICS	115, 118, 119
YAMAHA	120, 121, 122

To control a DAT deck

Maker	Code(s)
SONY	203
PIONEER	219

To control an MD deck

Maker	Code(s)
SONY	301
DENON	302
JVC	303
KENWOOD	304

To control a tape deck

Maker	Code(s)
SONY	201, 202
DENON	204, 205
KENWOOD	206, 207, 208, 209
NAKAMICHI	210
PANASONIC	216
PHILIPS	211, 212
PIONEER	213, 214
TECHNICS	215, 216
YAMAHA	217, 218

To control an LD player

Maker	Code(s)
SONY	601, 602, 603
PIONEER	606

To control a video CD player

Maker	Code(s)
SONY	605

To control a DVD recorder

Maker	Code(s)
SONY	401, 402, 403

To control a VCR

Maker	Code(s)
SONY	701, 702, 703, 704, 705, 706
AIWA*	710, 750, 757, 758
AKAI	707, 708, 709, 759
BLAUPUNKT	740
EMERSON	711, 712, 713, 714, 715, 716, 750
FISHER	717, 718, 719, 720
GENERAL ELECTRIC (GE)	721, 722, 730
GOLDSTAR/LG	723, 753
GRUNDIG	724
HITACHI	722, 725, 729, 741
ITT/NOKIA	717
JVC	726, 727, 728, 736
MAGNAVOX	730, 731, 738
MITSUBISHI/MGA	732, 733, 734, 735
NEC	736
PANASONIC	729, 730, 737, 738, 739, 740
PHILIPS	729, 730, 731
PIONEER	729
RCA/PROSCAN	722, 729, 730, 731, 741, 747
SAMSUNG	742, 743, 744, 745
SANYO	717, 720, 746
SHARP	748, 749
TELEFUNKEN	751, 752
TOSHIBA	747, 756
ZENITH	754

* If an AIWA VCR does not work even though you enter the code for AIWA, enter the code for Sony instead.

To control a DVD player

Maker	Code(s)
SONY	401, 402, 403
BROKSONIC	424
DENON	405
HITACHI	416
JVC	415, 423
MITSUBISHI	419
ORITRON	417
PANASONIC	406, 408, 425
PHILIPS	407
PIONEER	409, 410
RCA	414
SAMSUNG	416, 422
TOSHIBA	404, 421
ZENITH	418, 420

To control a DVD recorder

Maker	Code(s)
SONY	401, 402, 403

To control a TV

Maker	Code(s)
SONY	501
AIWA	501, 536, 539
AKAI	503
AOC	503
CENTURION	566
CORONADO	517
CURTIS-MATHES	503, 551, 566, 567
DAYTRON	517, 566
DAEWOO	504, 505, 506, 507, 515, 544
FISHER	508, 545
FUNAI	548
FUJITSU	528
GOLDSTAR/LG	503, 512, 515, 517, 534, 544, 556, 568
GRUNDIG	511, 533, 534
HITACHI	503, 513, 514, 515, 517, 519, 544, 557, 571
ITT/NOKIA	521, 522
J.C.PENNY	503, 510, 566
JVC	516, 552
KMC	517
MAGNAVOX	503, 515, 517, 518, 544, 566
MARANTZ	527
MITSUBISHI/MGA	503, 519, 527, 544, 566, 568
NEC	503, 517, 520, 540, 544, 554, 566
NORDMENDE	530, 558
NOKIA	521, 522, 573, 575
PANASONIC	509, 524, 553, 559, 572
PHILIPS	515, 518, 557, 570, 571
PHILCO	503, 504, 514, 517, 518
PIONEER	509, 525, 526, 540, 551, 555
PORTLAND	503
QUASAR	509, 535
RADIO SHACK	503, 510, 527, 565, 567
RCA/PROSCAN	503, 510, 523, 529, 544
SAMSUNG	503, 515, 517, 531, 532, 534, 544, 556, 557, 562, 563, 566, 569
SAMPO	566
SABA	530, 537, 547, 549, 558
SANYO	508, 545, 546, 560, 567
SCOTT	503, 566
SEARS	503, 508, 510, 517, 518, 551
SHARP	517, 535, 550, 561, 565
SYLVANIA	503, 518, 566

Maker	Code(s)
THOMSON	530, 537, 547, 549
TOSHIBA	535, 539, 540, 541, 551
TELEFUNKEN	530, 537, 538, 547, 549, 558
TEKNIKA	517, 518, 567
WARDS	503, 517, 566
YORK	566
ZENITH	542, 543, 567
GE	503, 509, 510, 544
LOEWE	515, 534, 556

To control a satellite tuner

Maker	Code(s)
SONY	801, 802, 803, 804, 824, 825, 865
AMSTRAD	845, 846
BskyB	862
GENERAL ELECTRIC(GE)	866
GRUNDIG	859, 860
HUMAX	846, 847
THOMSON	857, 861, 864, 876
PACE	848, 849, 850, 852, 862, 863, 864
PANASONIC	818, 855
PHILIPS	856, 857, 858, 859, 860, 864, 874
NOKIA	851, 853, 854, 864
RCA/PROSCAN	866, 871
BITA/HITACHI	868
HUGHES	867
JVC/Echostar/Dish Network	873
MITSUBISHI	872
SAMSUNG	875
TOSHIBA	869, 870

To control a cable box

Maker	Code(s)
SONY	821, 822, 823
HAMLIN/REGAL	836, 837, 838, 839, 840
JERROLD/G.I./ MOTOROLA	806, 807, 808, 809, 810, 811, 812, 813, 814, 819
JERROLD	830, 831
OAK	841, 842, 843
PANASONIC	816, 826, 832, 833, 834, 835
PHILIPS	830, 831
PIONEER	828, 829
RCA	805
SCIENTIFIC ATLANTA	815, 816, 817, 844
TOCOM/PHILIPS	830, 831
ZENITH	826, 827

To control a tuner

Maker	Code(s)
SONY	002, 005

To control a Blu-ray disc player

Maker	Code(s)
SONY	310, 311, 312

To control a PSX

Maker	Code(s)
SONY	313, 314, 315

To control a DVD/VHS COMBO

Maker	Code(s)
SONY	411

To control a DVD/HDD COMBO

Maker	Code(s)
SONY	401, 402, 403

Clearing all the contents of the remote's memory

While holding down **MASTER VOL -**, press and hold **I/⏻**, then press **AV I/⏻**.

The RM SET UP button flashes three times. All the contents of the remote's memory (i.e., all the programmed data) are cleared.

Glossary

■ Cinema Studio EX

A surround sound mode that can be regarded as the compilation of Digital Cinema Sound technology, delivers the sound of a dubbing theater using three technologies: “Virtual Multi Dimensions”, “Screen Depth Matching”, and “Cinema Studio Reverberation”.

“Virtual Multi Dimensions”, the virtual speaker technology, creates a virtual multi-surround environment with actual speakers up to 7.1 channels, and brings the surround sound experience of a theater with the latest facilities into your home.

“Screen Depth Matching” reproduces treble attenuation, fullness, and depth of sound usually created in a theater using sound emission from behind the screen. This is then added to the front and center channels.

“Cinema Studio Reverberation” reproduces the sound characteristics of state-of-the-art dubbing theaters and recording studios, including Sony Pictures Entertainment’s dubbing studios. There are three modes, A/B/C, available according to the studio type.

■ Component video

A format for transmitting video signal information consisting of three separate signals: luminance Y, chrominance Pb, and chrominance Pr. High quality pictures, such as DVD video or HDTV pictures, are transmitted more faithfully. The three jacks are color-coded green, blue, and red.

■ Composite video

A standard format for transmitting video signal information. The luminance signal Y and chrominance signal C are combined and transmitted together.

■ Crossover frequency

The frequency at which two speaker’s frequencies intersect.

■ Deep Color

Video signals for which the color depth of signals passing through an HDMI jack have been raised.

The number of colors that could be expressed by 1 pixel was 24 bits (16,777,216 colors) with the current HDMI jack. However, the number of colors which can be expressed by 1 pixel will be 36, etc., bits when the receiver corresponds to Deep Color.

Since the gradation of the depth of a color can be expressed more finely with more bits, continuous color changes can be more smoothly expressed.

■ Digital Cinema Sound (DCS)

Unique sound reproduction technology for home theater developed by Sony, in cooperation with Sony Pictures Entertainment, for enjoying the exciting and powerful sound of movie theaters at home. With this “Digital Cinema Sound” developed by integrating a DSP (Digital Signal Processor) and measured data, the ideal sound field intended by filmmakers can be experienced at home.

■ Dolby Digital

Digital audio encoding/decoding technology developed by Dolby Laboratories, Inc. It consists of front (left/right), center, surround (left/right) and subwoofer channels. It is a designated audio standard for DVD-video and also known as 5.1 channels surround. Since surround information is recorded and reproduced in stereo, more realistic sound with fuller presence is delivered than with Dolby surround.

■ **Dolby Digital Plus**

Dolby Digital Plus provides the flexibility and efficiency to deliver more channels of compelling surround sound for high-definition video media. Its superior coding efficiencies enable up to 7.1ch of high-quality multichannel audio without negatively impacting bit budgets allocated for video performance or additional feature sets.

■ **Dolby Digital Surround EX**

Acoustic technology developed by Dolby Laboratories, Inc. Surround back information is matrixed into regular left and right surround channels so that the sound can be reproduced in 6.1 channels. Active scenes, especially, are recreated with a more dynamic and realistic sound field.

■ **Dolby Pro Logic II**

This technology converts 2 channels stereo recorded audio into 5.1 channels for playback. There is a MOVIE mode for movies and MUSIC mode for stereo sources such as music. Old movies encoded in the traditional stereo format can be enhanced with 5.1 channels surround sound. The GAME mode is suitable for video games.

■ **Dolby Pro Logic IIx**

Technology for 7.1 channels (or 6.1 channels) playback. Along with audio encoded in Dolby Digital Surround EX, 5.1 channels Dolby Digital encoded audio can be reproduced in 7.1 channels (or 6.1 channels). Furthermore, existing stereo recorded content can also be reproduced in 7.1 channels (or 6.1 channels).

■ **Dolby Surround (Dolby Pro Logic)**

Audio processing technology developed by Dolby Laboratories, Inc. Center and mono surround information is matrixed into two stereo channels. When reproduced, audio is decoded and output in 4 channels surround sound. This is the most common audio processing method for DVD-video.

■ **Dolby TrueHD**

Dolby TrueHD is Dolby's lossless audio technology developed for high-definition optical discs. Dolby TrueHD audio is bit-for-bit identical to the original studio masters and provides supreme-quality audio up to 8ch at 96 kHz/24 bit and up to 6ch at 192 kHz/24 bit. Together with high-definition video, it offers an unprecedented home theater experience.

■ **DTS 96/24**

A high sound quality digital signal format. It records audio at a sampling frequency and bit rate of 96 kHz/24 bit which is the highest possible for DVD-video. The number of playback channels varies depending on the software.

■ **DTS Digital Surround**

Digital audio encoding/decoding technology for theaters developed by DTS, Inc. It compresses audio less than Dolby Digital, delivering a higher quality sound reproduction.

■ **DTS-ES**

Format for 6.1 channels playback with surround back information. There are two modes, "Discrete 6.1" which records all channels independently, and "Matrix 6.1" which matrixes surround back channel into surround left and surround right channels. It is ideal for playback of motion picture soundtracks.

■ DTS-HD

Audio format which extends the conventional DTS Digital Surround format.

This format consists of a core and an extension, and the core part has DTS Digital Surround compatibility. There are two kinds of DTS-HD, DTS-HD High Resolution Audio and DTS-HD Master Audio. DTS-HD High Resolution Audio has a maximum transmission rate of 6 Mbps, with lossy compression (Lossy), and DTS-HD High Resolution Audio corresponds to a maximum sampling frequency of 96 kHz, and a maximum of 7.1 ch. DTS-HD Master Audio has the maximum transmission rate of 24.5 Mbps, and uses lossless compression (Lossless), and DTS-HD Master Audio corresponds to a maximum sampling frequency of 192 kHz, and a maximum of 7.1 ch.

■ DTS Neo:6

This technology converts 2 channels stereo recorded audio for 7 channels playback. There are two modes to select according to the playback source or your preference, CINEMA for movies, and MUSIC for stereo sources such as music.

■ HDMI (High-Definition Multimedia Interface)

HDMI (High-Definition Multimedia Interface) is an interface that supports both video and audio on a single digital connection, allowing you to enjoy high quality digital picture and sound. The HDMI specification supports HDCP (High-bandwidth Digital Contents Protection), a copy protection technology that incorporates coding technology for digital video signals.

■ High Bitrate Audio

It refers to the audio formats of the compression method (DTS-HD Master Audio, Dolby TrueHD, etc.) which is a high bitrate format recorded mainly on Blu-ray Disc etc.

■ Interlace

A scanning method which completes a picture by displaying half of the lines on a tube surface of a TV or monitor each 1/60 second. First, all the odd-numbered lines are drawn, leaving spaces between each line, then all the even-numbered lines are drawn to fill the spaces. “i” of “480i” stands for “Interlace”.

■ L.F.E. (Low Frequency Effects)

Sound effects of low frequencies which are output from a subwoofer in Dolby Digital or DTS, etc. By adding a deep bass with a frequency between 20 to 120 Hz, audio becomes more powerful.

■ Neural-THX

Neural-THX[®] Surround is taking surround sound to the next level. This revolutionary new technology delivers the rich envelopment and discrete image detail of surround sound in a format that is fully compatible with stereo. Neural-THX Surround reduces the bandwidth needed for broadcasters to deliver true, multi channel surround presentations, and enables 7.1-channel support for gaming and movies. By unmasking the audio details, typically lost by other playback systems, audiences will experience the deep ambience and subtle details of movies, music and games. And with this technology being used by sound designers during content creation, as well as embedded into playback devices, Neural-THX Surround promises a listening experience that is true to the original mix.

Neural-THX Surround has been chosen as the official surround sound broadcast format for XM Satellite Radio’s “XM HD Surround”, as well as other leading FM/HD radio stations worldwide.

For additional information, please visit www.neuralsurround.com.

■ PCM (Pulse Code Modulation)

A method of converting analog audio to digital audio for easy enjoyment of digital sound.

■ Progressive

A scanning method that draws all scanning lines sequentially, as opposed to interlaced scanning where all the odd and then all the even lines are drawn.

“p” of “480p” stands for “Progressive”.

■ x.v.Color

x.v.Color is a more familiar term for the xvYCC standard proposed by Sony, and is a trademark of Sony. xvYCC is an international standard for color space in video.

This standard can express a wider color range than the currently used broadcast standard.

Precautions

On safety

Should any solid object or liquid fall into the cabinet, unplug the receiver and have it checked by qualified personnel before operating it any further.

On power sources

- Before operating the receiver, check that the operating voltage is identical with your local power supply.
The operating voltage is indicated on the nameplate on the back of the receiver.
- The unit is not disconnected from the AC power source (mains) as long as it is connected to the wall outlet, even if the unit itself has been turned off.
- If you are not going to use the receiver for a long time, be sure to disconnect the receiver from the wall outlet. To disconnect the AC power cord (mains lead), grasp the plug itself; never pull the cord.
- One blade of the plug is wider than the other for the purpose of safety and will fit into the wall outlet only one way. If you are unable to insert the plug fully into the outlet, contact your dealer.
- AC power cord (mains lead) must be changed only at a qualified service shop.

On heat buildup

Although the receiver heats up during operation, this is not a malfunction. If you continuously use this receiver at a large volume, the cabinet temperature of the top, side and bottom rises considerably. To avoid burning yourself, do not touch the cabinet.

On placement

- Place the receiver in a location with adequate ventilation to prevent heat buildup and prolong the life of the receiver.
- Do not place the receiver near heat sources, or in a place subject to direct sunlight, excessive dust, or mechanical shock.
- Do not place anything on top of the cabinet that might block the ventilation holes and cause malfunctions.
- Do not place the receiver near equipment such as a television, VCR, or tape deck. (If the receiver is being used in combination with a television, VCR, or tape deck, and is placed too close to that equipment, noise may result, and picture quality may suffer. This is especially likely when using an indoor antenna (aerial). Therefore, we recommend using an outdoor antenna (aerial).)

On operation

Before connecting other components, be sure to turn off and unplug the receiver.

On cleaning

Clean the cabinet, panel, and controls with a soft cloth slightly moistened with a mild detergent solution. Do not use any type of abrasive pad, scouring powder, or solvent, such as alcohol or benzine.

If you have any questions or problems concerning your receiver, please consult your nearest Sony dealer.

Troubleshooting

If you experience any of the following difficulties while using the receiver, use this troubleshooting guide to help you remedy the problem. Should any problem persist, consult your nearest Sony dealer.

Audio

There is no sound, no matter which component is selected, or only a very low-level sound is heard.

- Check that the speakers and components are connected securely.
- Check that all speaker cords are connected correctly.
- Check that both the receiver and all components are turned on.
- Check that MASTER VOLUME control is not set at $-\infty$ dB. Try to set it at about -40 dB.
- Check that SPEAKERS (OFF/A/B/A+B) is not set to off (page 44).
- Press MUTING on the remote to cancel the muting function.
- Check that you have selected the correct component with INPUT SELECTOR.
- Check that headphones are not connected.
- When only a very low-level sound is heard, check to see if NIGHT MODE is activated (page 66).
- The protective device on the receiver has been activated. Turn off the receiver, eliminate the short-circuit problem, and turn on the power again.

There is no sound from a specific component.

- Check that the component is connected correctly to the audio input jacks for that component.
- Check that the cord(s) used for the connection is (are) fully inserted into the jacks on both the receiver and the component.

There is no sound from one of the front speakers.

- Connect a pair of headphones to the PHONES jack to verify that sound is output from the headphones. If only one channel is output from the headphones, the component may not be connected to the receiver correctly. Check that all the cords are fully inserted into the jacks on both the receiver and the component. If both channels are output from the headphones, the front speaker may not be connected to the receiver correctly. Check the connection of the front speaker which is not outputting any sound.
- Make sure you have connected both the L or R jack to an analog component and not just to either the L or R jack. Use a monaural-stereo cable (not supplied).

There is no sound from analog 2 channel sources.

- Check to make sure the selected audio (digital) input jack is not assigned to other inputs in “Input Assign” in the Input menu (page 98).

There is no sound from digital sources (from COAXIAL or OPTICAL input jack).

- Check that the INPUT MODE is set to “AUTO” (page 97).
- Check that the “Analog Direct” is not being used.
- Check to make sure the selected audio (digital) input jack is not assigned to other inputs in “Input Assign” in the Input menu (page 98).

The left and right sounds are unbalanced or reversed.

- Check that the speakers and components are connected correctly and securely.
- Adjust the balance parameters using the Speaker setting menu in GUI menu.

There is severe hum or noise.

- Check that the speakers and components are connected securely.
- Check that the connecting cords are away from a transformer or motor, and at least 10 feet (3 meters) away from a TV set or fluorescent light.
- Move your TV away from the audio components.
- Make sure you have grounded the \hbar SIGNAL GND terminal (only when a turntable is connected).
- The plugs and jacks are dirty. Wipe them with a cloth slightly moistened with alcohol.

There is no sound, or only a very low-level sound is heard from the center/surround/surround back speakers.

- Select a “Cinema Studio EX” mode (page 64).
- Adjust the speaker level (page 66).

There is no sound from the subwoofer.

- Check that the subwoofer is connected correctly and securely.
- Make sure you have turned on your speaker.
- When all speakers are set to “LARGE” and “Neo:6 Cinema”, or “Neo:6 Music” is selected, there is no sound from the subwoofer.

The surround effect cannot be obtained.

- Make sure the sound field function is on (press MOVIE).
- Sound fields do not function for signals with a sampling frequency of more than 48 kHz.

Dolby Digital or DTS multi channel sound is not reproduced.

- Check that the DVD, etc. you are playing is recorded in Dolby Digital or DTS format.
- When connecting the DVD player, etc., to the digital input jacks of this receiver, make sure the setting for the digital audio output of the connected component is available.

Recording cannot be carried out.

- Check that the components are connected correctly (page 19).
- Select the source component using INPUT SELECTOR (page 50).

The MULTI CHANNEL DECODING lamp does not light up in blue.

- Check that the playback component is connected on a digital jack and the input is selected properly on this receiver.
- Check whether the input source of the software being played back corresponds to the multi channel format.
- Check whether the setup on the playback component is set to multi channel sound.
- Check to make sure the selected audio (digital) input jack is not assigned to other inputs in “Input Assign” in the Input menu (page 98).

There is no sound from the component connected to the DIGITAL MEDIA PORT adapter.

- Adjust the volume of this receiver.
- The DIGITAL MEDIA PORT adapter and/or component is not connected correctly. Turn off the receiver, then reconnect the DIGITAL MEDIA PORT adapter and/or component.
- Check the DIGITAL MEDIA PORT adapter and/or component device to make sure it supports this receiver.

Video

There is no picture or an unclear picture appears on the TV screen or monitor.

- Select the appropriate input on the receiver (page 50).
- Set your TV to the appropriate input mode.
- Move your TV away from the audio components.
- Assign the component video input correctly.
- The input signal should be same as the input function when you are up-converting an input signal with this receiver (page 32).

Recording cannot be carried out.

- Check that the components are connected correctly (page 24).
- Select the source component using INPUT SELECTOR (page 50).

The GUI mode does not appear on the TV screen.

- Press GUI MODE repeatedly to select “GUI ON”. If the GUI menu still does not appear on the TV screen, press MENU.
- Check the TV is connected correctly.

HDMI

The source sound input to the HDMI jack is not output from the receiver or the TV speaker.

- Check the setting of “Audio Out” in the HDMI settings menu (page 57).
- Check that the component is connected correctly to the HDMI jack for that component.
- You cannot listen to the Super Audio CD by connecting HDMI.
- Depending on the playback component, you may need to set up the component. Refer to the operating instructions supplied with each component.
- Be sure to use a connecting cable for the HDMI jack corresponding to high speed (an HDMI version 1.3a, category 2 cable) when you view images or listen to sound during a Deep Color transmission.

The source image input to the HDMI jack is not output from the TV.

- Check the HDMI connection (page 26).
- Depending on the playback component, you may need to set up the component. Refer to the operating instructions supplied with the each component.
- Be sure to use a connecting cable for the HDMI jack corresponding to high speed (an HDMI version 1.3a, category 2 cable) when you view images or listen to sound during a Deep Color transmission.

The Control for HDMI function does not work.

- Check the HDMI connection (page 26).
- Make sure “Control for HDMI” is set to “ON” in the HDMI menu.
- Make sure the connected component is compatible with the Control for HDMI function.
- Check the Control for HDMI settings on the connected component. Refer to the operating instructions of the connected component.
- If you change the HDMI connection, connect/disconnect the AC power cord, or there is a power failure, repeat the procedures of “Preparing Control for HDMI function” (page 89).

No sound is output from the receiver and TV speaker while using the System Audio Control function.

- Make sure the TV is compatible with the System Audio Control function.
- If the TV does not have System Audio Control function, set the “Audio Out” settings in HDMI menu to
 - “TV+AMP” if you want to listen to the sound from the TV speaker and receiver.
 - “AMP” if you want to listen to the sound from the receiver.
- If you cannot listen to the sound of a component connected to the receiver
 - Change the input of the receiver to HDMI when you want to watch a program on a component connected via HDMI connection to the receiver.
 - Change the TV channel when you want to watch a TV broadcast.
 - Select the component or input you want to watch when you watch a program on the component connected to the TV. Refer to the operating instructions of the TV on this operation.

The TV's remote commander cannot be used to control the connected component when using the Control for HDMI function.

- Change the input of the receiver to the HDMI input connected to the component.

Tuner

The FM reception is poor.

- Use a 75-ohm coaxial cable (not supplied) to connect the receiver to an outdoor FM antenna (aerial) as shown below. If you connect the receiver to an outdoor antenna (aerial), ground it against lightning. To prevent a gas explosion, do not connect the ground (earth) wire to a gas pipe.

Outdoor FM antenna (aerial)

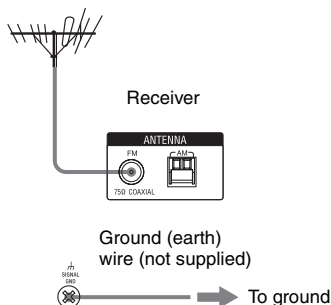

Radio stations cannot be tuned in.

- Check that the antennas (aerials) are connected securely. Adjust the antennas (aerials) and connect an external antenna (aerial), if necessary.
- Keep the satellite radio antenna, away from the speaker cords and the power cord to avoid picking up noise.
- The signal strength of the stations is too weak (when tuning in with automatic tuning). Use direct tuning.
- Make sure you set the tuning interval correctly (when tuning in AM stations with direct tuning).
- No stations have been preset or the preset stations have been cleared (when tuning by scanning preset stations). Preset the stations (page 75).
- Press DISPLAY so that the frequency appears on the display.

The system cannot receive satellite channels at all.

- The receiving condition is not good. Move the antenna to the place where the condition is good.
- Check that you subscribed to the desired satellite radio service (see page 76).

Remote control

The remote does not function.

- Point the remote at the remote sensor on the receiver.
 - Remove any obstacles in the path between the remote and the receiver.
 - Replace all the batteries in the remote with new ones, if they are weak.
 - Make sure that the command modes of the receiver and the remote are the same. If the command mode of the receiver and the remote are different, you cannot operate the receiver with the remote (page 37).
 - Make sure you select the correct input on the remote.
 - When you operate a programmed non-Sony component, the remote may not function properly depending on the model and the maker of the component.
-

Error messages

If there is a malfunction, the display shows a code of two numbers and a message. You can check the condition of the system by the message. Refer to the following table to solve the problem. If any problem persists, consult your nearest Sony dealer.

PROTECTOR

Irregular current is output to the speakers, or the upper panel of the receiver is covered with something. The receiver will automatically turn off after a few seconds. Check the connection of speakers and turn on the power again.

For other messages, refer to “Message list after Auto Calibration measurement” (page 49), “XM Radio messages list” (page 85), “SIRIUS Satellite Radio message list” (page 86) and “DIGITAL MEDIA PORT message list” (page 96).

Reference sections for clearing the memory

To clear	See
All memorized settings	page 36
Customized sound fields	page 36

Specifications

AUDIO POWER SPECIFICATIONS

POWER OUTPUT AND TOTAL HARMONIC DISTORTION:

With 8 ohm loads, both channels driven, from 20 – 20,000 Hz; rated 100 watts per channel minimum RMS power, with no more than 0.09% total harmonic distortion from 250 milliwatts to rated output.

Amplifier section

Power Output

Rated Power Output at Stereo Mode¹⁾
(8 ohms 20 Hz – 20 kHz, THD 0.09%):
100 W + 100 W

Reference Power Output at Stereo Mode
(4 ohms 20 Hz – 20 kHz, THD 0.15%):
85 W + 85 W

Reference Power Output (8 ohms 1 kHz, THD 0.7%)

FRONT²⁾: 110 W + 110 W

CENTER²⁾: 110 W

SURROUND²⁾: 110 W + 110 W

SUR BACK²⁾: 110 W + 110 W

Reference Power Output (4 ohms 1 kHz, THD 0.7%)

FRONT²⁾: 100 W + 100 W

CENTER²⁾: 100 W

SURROUND²⁾: 100 W + 100 W

SUR BACK²⁾: 100 W + 100 W

¹⁾Measured under the following conditions:
120 V AC, 60 Hz

²⁾Depending on the sound field settings and the source, there may be no sound output.

Frequency response

PHONO RIAA equalization curve
± 0.5 dB

Analog 10 Hz – 100 kHz,
± 3 dB (with sound field
and equalizer bypassed)

Input

PHONO	Sensitivity: 2.5 mV Impedance: 50 kohms S/N ³⁾ : 90 dB (A, 20 kHz LPF) ⁴⁾
Analog	Sensitivity: 150 mV/ 50 kohms S/N ³⁾ : 100 dB (A, 20 kHz LPF) ⁴⁾
Digital (Coaxial)	Impedance: 75 ohms S/N ³⁾ : 96 dB (A, 20 kHz LPF) ⁴⁾
Digital (Optical)	S/N ³⁾ : 96 dB (A, 20 kHz LPF) ⁴⁾

Output (analog)

AUDIO OUT	Voltage: 150 mV/ 1 kohm
SUBWOOFER	Voltage: 2 V/1 kohm

Equalizer
Gain levels ±10 dB, 1 dB step

³⁾INPUT SHORT (with sound field and equalizer bypassed).

⁴⁾Weighted network, input level.

FM tuner section

Tuning range	87.5 – 108.0 MHz
Antenna (aerial)	FM wire antenna (aerial)
Antenna (aerial) terminals	75 ohms, unbalanced
Intermediate frequency	10.7 MHz

AM tuner section

Tuning range	With 10-kHz tuning scale 530 – 1,710 kHz ⁵⁾ With 9-kHz tuning scale 531 – 1,710 kHz ⁵⁾
Antenna (aerial)	Loop antenna (aerial)
Intermediate frequency	450 kHz

⁵⁾You can change the AM tuning scale to either 9 kHz or 10 kHz. After tuning in any AM station, turn off the receiver. While holding down TUNING MODE, press POWER on the receiver. All preset stations will be erased when you change the tuning scale. To reset the scale to 10 kHz (or 9 kHz), repeat the procedure.

continued

Video section

Inputs/Outputs

Video: 1 Vp-p, 75 ohms

COMPONENT VIDEO:

Y: 1 Vp-p, 75 ohms

P_B/C_B: 0.7 Vp-p, 75 ohms

P_R/C_R: 0.7 Vp-p, 75 ohms

80 MHz HD Pass Through

HDMI Video

Input/Output (HDMI Repeater block)

640 × 480p@60 Hz

720 × 480p@59.94/60 Hz

1440 × 480p@59.94/60 Hz (pixel sent 2 times)

1280 × 720p@59.94/60 Hz

1920 × 1080i@59.94/60 Hz

1920 × 1080p@59.94/60 Hz

720 × 576p@50 Hz

1440 × 576p@50 Hz (pixel sent 2 times)

1280 × 720p@50 Hz

1920 × 1080i@50 Hz

1920 × 1080p@50 Hz

1920 × 1080p@24 Hz

General

Power requirements 120 V AC, 60 Hz

Power output (DIGITAL MEDIA PORT)

DC OUT: 5 V, 0.7 A MAX

Power consumption 350 W

Power consumption (during standby mode)

0.7 W (when “HDMI Control” and “RS-232C Control” are set to “OFF”)

Dimensions 17 × 6 1/4 × 15 3/8 inches
(430 × 157.5 × 388 mm)
(width/height/depth)
including projecting parts
and controls

Mass (Approx.) 26 lb 15 oz (12.2 kg)

Supplied accessories

Operating Instructions (this manual)

Quick Setup Guide (1)

GUI Menu List (1)

Optimizer microphone (ECM-AC2) (1)

FM wire antenna (aerial) (1)

AM loop antenna (aerial) (1)

AC power cord (mains lead) (1)

Remote commander (RM-AAP025) (1)

Remote commander (RM-AAU039) (1)

R6 (size-AA) batteries (4)

Design and specifications are subject to change without notice.

Index

Symbols

⌘ SIGNAL GND terminal 23

Numerics

2 channel 60
2ch Stereo Mode 60
4 ohms 43
5.1 channel 14
7.1 channel 15
8 ohms 43

A

A.F.D. (mode) 62
A/V Sync 56
AC power cord 36
AM 73, 100, 115
Analog Direct 60
Audio (Settings) 56
Auto Calibration 44, 108, 113
Auto Tuning 73, 115

B

Bass 72
BI-AMP SP 109
Bi-amplifier connection 105
Blu-ray disc player 26, 53

C

Calibration Type Select 48, 108
Category Mode 80, 117
CD player 20, 23, 52
Changing the display 100
Cinema Studio EX (mode) 64
Clear
 memory 36
Command mode 37
Connections
 antennas 35
 audio components 19
 monitor 18
 speakers 16
 video components 24
Control for HDMI
 connecting 88
 preparing 89
Crossover Freq 71, 109

D

D.Range Comp (Dynamic range compressor)
 72
DCAC (Digital Cinema Auto Calibration) 44
DCS 64
Decode Priority 56
DIGITAL MEDIA PORT 9, 14, 20, 92
Direct Tuning 74, 81, 115, 117
Display window 101
Distance 67
Distance Unit 72
Dolby Digital EX 61
DTS Neo:6 (Cinema, Music) 62
Dual Mono 56
DVD player 26, 29, 53
DVD recorder 31

E

Effect Level 110
Enhanced Setup 49
EQ (Settings) 72
Equalizer 72

F

FM 73, 100, 115
FM Mode 74, 110

G

Gain Adjusting (Bass/Treble) 72
GUI (Graphical User Interface) 18, 39

H

HDMI (Settings) 57, 111
HDMI jacks 8, 25
Headphone (Settings) 64

I

Input 50
Input Assign 98
INPUT MODE 97
INPUT SELECTOR 52–55
iPod 93, 94

L

LARGE 68
Level 67, 72
LFE (Low Frequency Effect) 101
List Mode 95
Lock Code 84

M

Manual Setup 66, 67
MASTER VOLUME 7, 52–55
Messages
 Auto Calibration 49
 DIGITAL MEDIA PORT 96
 error 134
 SIRIUS 86
 XM 85

Movie 64
MULTI CHANNEL DECODING lamp 53
Music 64
Muting 51

N

Name Input 96
Network Client 94
Neural-THX 62
NIGHT MODE 66

P

Parental Lock 83
Phase Audio 71, 108
Phase Noise 71, 108
PHONES 7
PLII 62
PLIIX 62
Position (Auto Calibration) 49
Preset channels 82, 118
Preset Mode 82
Preset stations 75, 115
PROTECTOR 134

R

Radio ID 79, 110, 117
Recording 104, 105
Remote 9–14, 37, 118–124
Resetting 36
Resolution 57, 87, 92, 111
RS-232C Control 58

S

Satellite radio 76
SIRIUS Satellite Radio 77
Size 68
Sleep timer 104
SMALL 68
Sound Field Select 59
Sound Field Setup 59
Speaker (Settings) 42, 71, 109
Speaker Impedance 42
Speaker Pattern 69
SPEAKERS (OFF/A/B/A+B) 7, 44
Super Audio CD player 20, 22, 23, 52
Surround 59
Surround Settings 110
System (Settings) 58, 111, 112

T

Test Tone 70, 71, 108
TONE +/- 7
TONE MODE 7, 36
Treble 72
Tuner 73
Tuner (Settings) 110
Tuning 73, 74, 75

U

Up converting 32

V

VCR 31, 55

Video (Settings) 57, 111

VIDEO 2 IN/PORTABLE AV IN jacks 31, 54

Video game 54

X

XM Radio 76



* 3 2 8 9 2 0 4 1 2 * (1)

Sony Corporation Printed in Malaysia

<http://www.sony.net/>